

Operator's Manual Blanket Warmer

EC2060



0957-00354

REV. B
3/26

EN



Manufacturer's Information

Copyright

© Copyright 2/24 by Pedigo Products, Inc.
All rights reserved.

This manual or any portion thereof may not be reproduced or used in any manner whatsoever without the express written permission of Pedigo Products, Inc.

Trademarks

All trademarks referenced in this documentation are the property of their respective owners.

Manufacturer

Pedigo Products, Inc.
4000 S.E. Columbia Way
Vancouver, WA 98661, USA
1-800-822-3501
www.pedigo-usa.com

Original instructions

The content in this manual is written in American English.

Thank you for your Purchase!

This warmer has been thoroughly tested and inspected to ensure only the highest quality is provided. We supply the most durable, convenient, efficient and safe warming equipment on the market. All warmers are manufactured and fully inspected in the USA with a commitment to quality.

Enthermics Repair Service

Call

Call 360-695-3500 to reach our service call center for access to local authorized service agencies. Our call center is available M-F 7:00 a.m. to 5:00 p.m. PST.

Intended Use

Intended Use:

The fluid and combination warmer is a non-invasive, static heating device intended for the pre-procedural warming of unopened, medical grade fluid containers (such as IV bags or irrigation bottles), and/or blankets (combination warmers only) to their respective temperatures established by the facility and/or manufacturer of the product being heated.

The blanket warmer is a non-invasive, static heating device intended for the pre-procedural warming of medical grade blankets to their respective temperatures established by the facility and/or manufacturer of the product being heated.

Scope of Use:

The device is designed for use in clinical environments by healthcare professionals prior to use with a patient.

Contraindications/Limitations:

- The device is **not** intended for the active circulation of fluids.
- The device is **not** an in-line warmer and shall not be connected to an active infusion set or the patient.
- The device is **not** intended for warming blood or blood products (whole red blood, red blood cells, plasma), or flammable liquids.
- No part of the device comes into contact with the patient or the fluid itself.

This page is intentionally left blank.

Manufacturer's Information 2

Foreword 3

 Thank you for your Purchase! 3

 Register Your Warmer..... 3

 Enthermics 24/7 Emergency Repair Service 3

Safety 7

 The Meaning of Signal Words..... 7

 Safety Precautions 8

Labels 11

 Label Locations 11

Specifications 13

 Specification Information 13

 Dimension Drawings 14

Installation 15

 How to Unpack the Warmer..... 15

 How to Install the Warmer 16

Operation 17

 Preparing the Warmer for First Use 17

 How to Turn On and Turn Off the Warmer..... 18

 How to Operate the Blanket Warmer 19

 How to Change the Temperature Scale 21

 How to Lock and Unlock the Controller..... 22

Maintenance 23

 Maintenance Schedule 23

 How to Clean the Warmer 25

Troubleshooting 27

 What to do if the Warmer Malfunctions 27

 Error Codes 28

Warranty 30

 Warranty 30

TABLE OF CONTENTS

This page is intentionally left blank.

The Meaning of Signal Words

This manual contains signal words where needed. These signal words must be obeyed to reduce the risk of death, personal injury, or equipment damage. The meaning of these signal words is explained below.

**DANGER**

Danger indicates a hazardous situation which, if not avoided, will result in serious injury or death.

**WARNING**

Warning indicates a hazardous situation which, if not avoided, could result in serious injury or death.

**CAUTION**

Caution indicates a hazardous situation which, if not avoided, could result in minor or moderate injury.

NOTICE

Notice indicates a situation which, if not avoided, could result in property damage.



NOTE: Note indicates additional information that is important to a concept or procedure.

Safety Precautions

Before you begin

Read and understand all instructions in this manual.

Electrical precautions

Obey these electrical precautions when using the warmer:

- Connect the warmer to a properly grounded outlet. Do not use the warmer if it is not properly grounded. Consult an electrician if there is any doubt that the outlet used is properly grounded.
 - Keep the cord away from hot surfaces.
 - Do not attempt to service the warmer or its cord and plug, when plugged in.
 - Do not operate the warmer if it has a damaged cord or plug.
 - Do not immerse the cord or plug in water.
 - Do not let the cord hang over the edge of a table or counter.
 - Do not use an extension cord.
-

Usage precautions

Obey these usage precautions when using the warmer:

- Only use this warmer for its intended use of warming medical solution bags, bottles, and/or blankets. Follow facility and solution manufacturer guidance regarding warming temperature for any item to be placed in the warmer.
 - Do not use this warmer for warming blood or blood products.
 - Do not cover or block any of the openings of this warmer.
 - Do not use this warmer in a wet location.
 - Only clean the warmer when the power cord is unplugged.
 - Do not use corrosive chemicals when cleaning the warmer.
 - Do not use the warmer cavity for storage.
 - Do not remove exterior panels from the warmer or attempt repairs. The warmer has no user-serviceable internal components. Only perform routine cleaning and maintenance procedures specifically described in this manual. Inspection and servicing of internal components must only be performed by qualified service personnel.
 - Only a qualified Enthermics service representative may make modifications to the warmer. Modifications to the warmer could be hazardous to users and patients.
-

Operator training

All personnel using the warmer must have proper operator training. Before using the warmer:

- Read and understand the operating instructions contained in all the documentation delivered with the warmer.
 - Know the location and proper use of all controls.
 - Keep this manual and all supplied instructions, diagrams, schematics, parts lists, notices, and labels with the warmer if the warmer is sold or moved to another location.
-

Operator qualifications

Only trained personnel with the following operator qualifications are permitted to use the warmer:

- Have received proper instruction on how to use the warmer.
 - Are familiar with the purpose, limitations, and associated hazards of the warmer.
-

The warmer must not be used by:

- People impaired by drugs or alcohol.
-

Condition of warmer

Only use the warmer when:

- All controls operate correctly.
 - The warmer is installed correctly.
 - The warmer is clean.
 - The warmer labels are legible.
-

Servicing the warmer

- Obey precautions in the manual, on tags, and on labels attached to or shipped with the warmer.
 - Only trained personnel are permitted to service or repair the warmer. Repairs that are not performed by a trained technician, or the use of non-factory parts, will void the warranty and relieve all liability.
 - Any troubleshooting guides and components views included with this manual are for reference only and are intended for use by qualified and trained service technicians.
 - To prevent serious injury, death or property damage, have the warmer inspected and serviced at least every twelve (12) months by a trained technician.
 - Contact Pedigo for the authorized service partner in your area.
-

Incident notice



- Any serious incident that has occurred in relation to the warmer should be reported to the manufacturer and the competent authority of the Member State in which the user and/or patient is established.

This page is intentionally left blank.

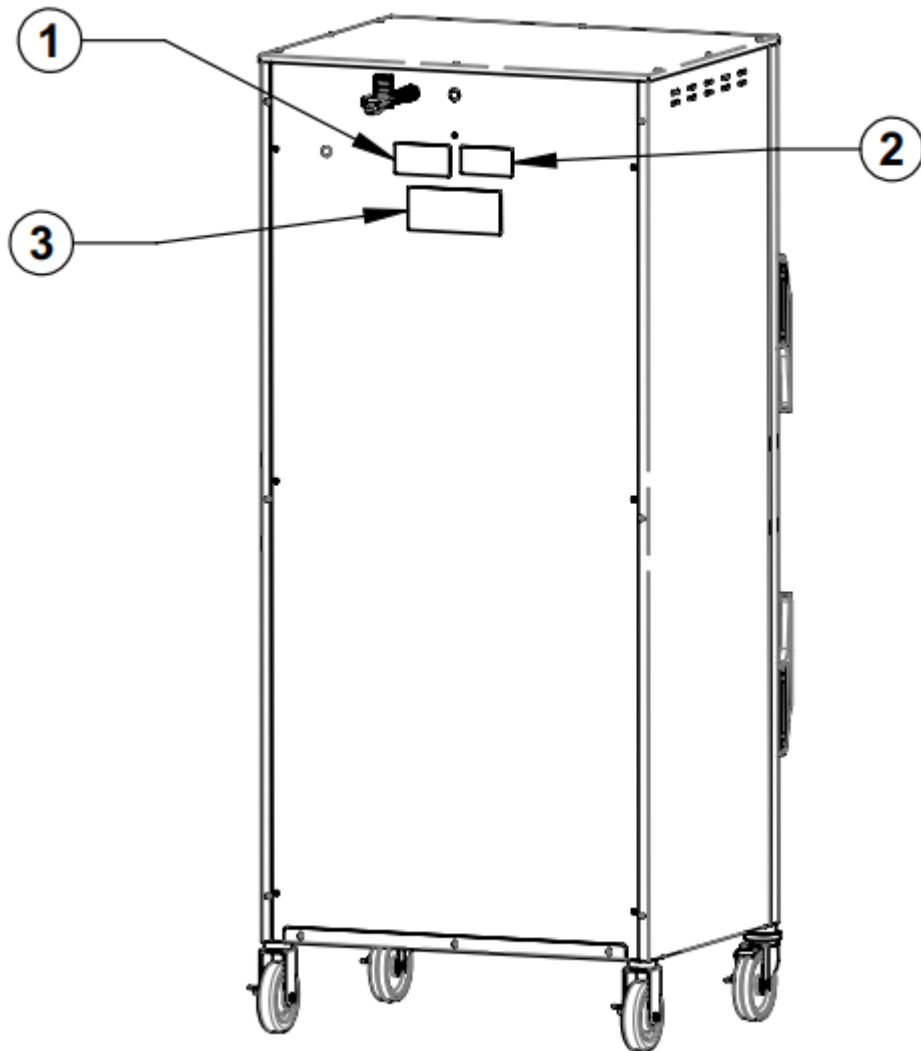
Label Locations

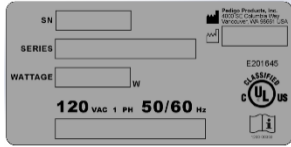

LABELS

<p>1</p>		<p>Serial Label</p>
<p>2</p>		<p>Pedigo contact information</p>
<p>3</p>		<p>Electrical warning label</p>

Specification Information

Model	EC2060
Intended use	Warming blankets
Weight	Net: 347 lbs (157 kg) Ship: 404 lbs (183 kg)
Storage cavity capacity	60–70 blankets (20.6 ft ³)
Temperature range	60°F to 160°F (16°C to 71°C)
Clearance requirements	4" (102mm) from rear 4" (102mm) from top 2" (51mm) from sides

Transportation and storage conditions

- Ambient temperature range of -40°F to +159°F (-40°C to +70°C).
- Relative humidity range of 10% to 95%, non-condensing.
- Atmospheric pressure range of 7.25 psi to 15.37 psi (50kPa to 106kPa).

Operating conditions

- The warmer must acclimate to the room temperature it will be placed in—24 hours is recommended.
- The recommended environmental temperature range is 60°F to 90°F (15°C to 32°C).
- The recommended relative humidity is above 20%, non-condensing.

Standards for electrical equipment

- Laboratory equipment listed by Underwriters Laboratories with respect to electrical shock, fire, and mechanical hazards only, in accordance with UL 61010-1 and CAN/CSA C22.2 No. 61010.1.
- Grounding reliability can only be achieved when the appliance is connected to an equivalent receptacle marked "Hospital Grade."
- IP-XO ordinary



SPECIFICATIONS

Dimension Drawings

EC2060

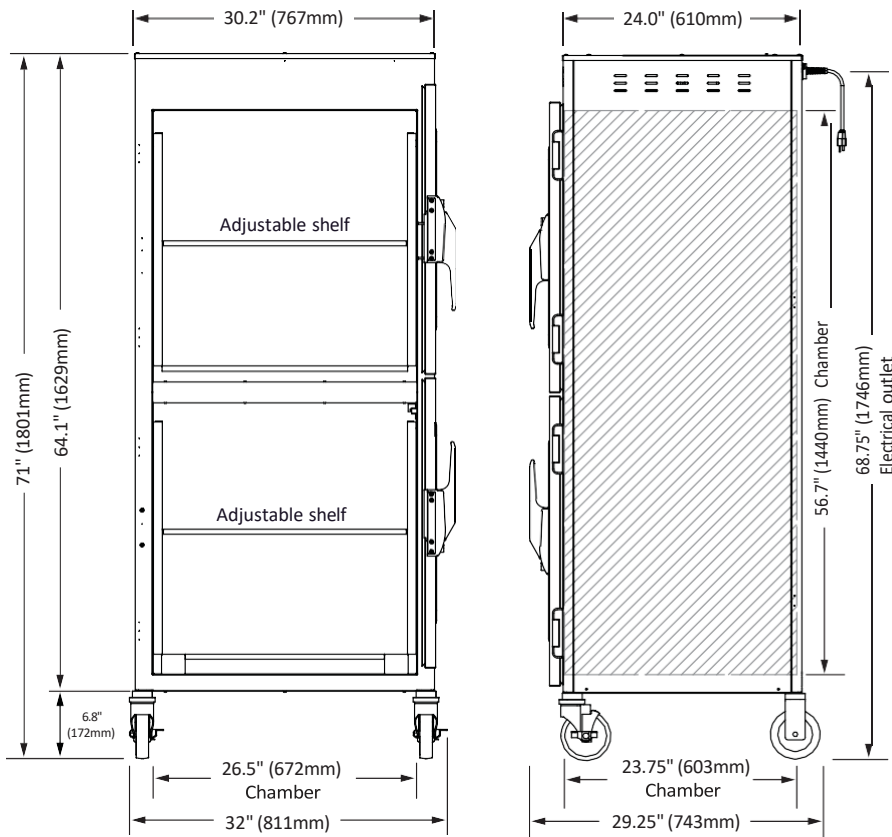
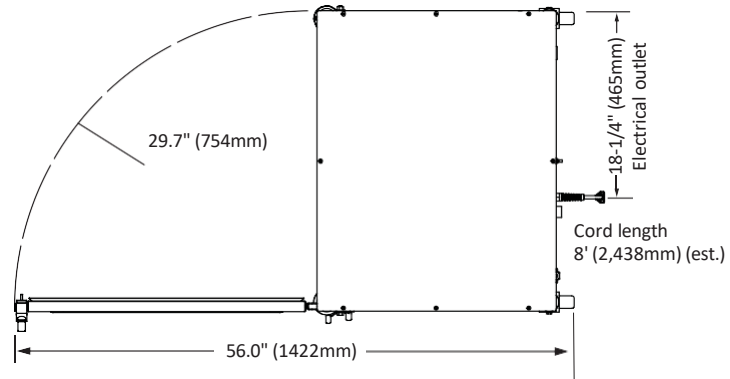

EC-DIM-004924

How to Unpack the Warmer



WARNING: Crushing hazard.

An unstable warmer can lead to a crushing hazard. Observe your facility's best practices for moving large equipment.

Before you begin

Make sure you have:

- Reviewed the warmer specifications.
- An appropriate lifting device and enough personnel to safely move and position the weight of the warmer.
- Cutting tools to remove the packaging.

Unpack the warmer

To unpack the warmer, do the following.

Step	Action
1.	<p>Remove the box or crate. Save all packing materials for inspection by the carrier.</p> <div style="border: 1px solid gray; padding: 5px; margin-top: 10px;"> <p>NOTE: Examine the warmer for damage. If the warmer has been damaged, do not use the warmer until it has been inspected by an authorized service provider. Contact your carrier or customer service.</p> </div>
2.	Cut and remove the retaining straps and plastic wrap.
3.	Remove the warmer from the pallet using an appropriate lifting device.
4.	Remove the paperwork from the cavity.

Result

The warmer is now unpacked.

How to Install the Warmer

Before you begin

Make sure you have:

An appropriate lifting device and enough personnel to safely move and position the weight of the warmer.

Requirements

- The warmer must be installed on a level surface.
- The warmer must not be installed in any area where it may be affected by steam, dripping water, high temperature, or any other severely adverse conditions.

Voltages

Model	V	Ph	Hz	kW
EC2060	120	1	50/60	1.8
	230	1	50/60	1.7

Position the warmer

To position the warmer, do the following.

Step	Action
1.	<p>Make sure that:</p> <ul style="list-style-type: none"> - The location where the warmer is being installed is rated to support the weight of the warmer; - The warmer is within five feet of the appropriate electrical outlet; - You follow the warmer clearance guidelines. Refer to topic <i>Specification Information</i> for clearance requirements.
2.	<p>Move the warmer to the installation location and onto the final resting surface.</p>
3.	<p>Lock the casters, if equipped.</p>

The warmer is now correctly positioned.

Connect power

To connect electric power to the warmer, do the following.

4.	<p>Connect the plug to the electrical outlet.</p>
----	--

Result

The warmer is now installed and ready to be used.

Preparing the Warmer for First Use

Before you begin



CAUTION: Burn hazard.
Allow the warmer to cool before cleaning.

NOTICE

Do not use:

- abrasive cleaning compounds.
- chloride based cleaners.
- commercial or household cleaners containing ammonia.

Procedure

To prepare the warmer for first use, do the following.

Step	Action
1.	Make sure that the warmer is turned off and cool.
2.	Wipe the outside of the warmer: <ul style="list-style-type: none"> - with a stainless-steel cleaner, if stainless steel panels. - with an approved cleaning agent, if painted panels.
3.	Clean the interior of the warmer with a damp cloth or approved cleaning agent.
4.	Dry the interior and exterior of the warmer with a clean, lint-free cloth. Leave the door open until the interior of the warmer completely dries.
5.	Clean each side of the window pane with glass cleaner or distilled vinegar.

Result

The warmer is now ready for use.

How to Turn On and Turn Off the Warmer

Before you begin

The warmer must be connected to electric power.

Turning on the warmer

To turn on the warmer, do the following.

Step	Action
------	--------

1. **Set** the power switch **1** to the ON (I) position.

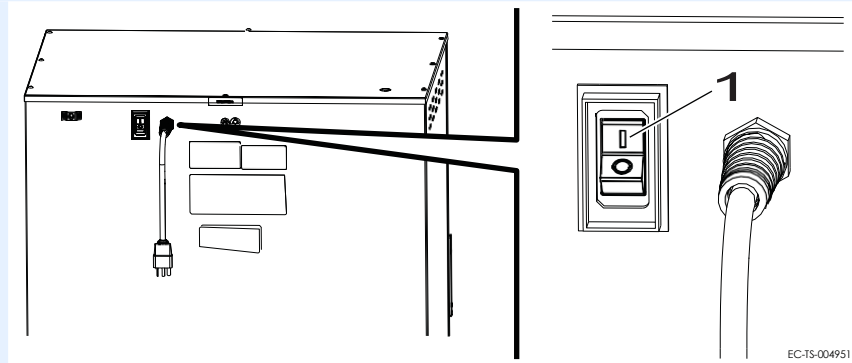

2. The screen turns on.

i **NOTE:** A temporary odor may be noticeable upon initial start-up of the warmer. Contact the manufacturer if the odor persists after a day or more of continuous use.

The warmer is now on.

Turning off the warmer

To turn off the warmer, do the following.

3. Rotate the Temperature Control Knob  to the off (vertical) position. The screen will display "0°F" or "0°C". Set the power switch to the OFF (O) position. The screen will not turn off unless the power switch is turned off.

i **NOTE:** If equipped, the fan will continue to operate after the warmer is turned off.

The warmer is now off.

How to Operate the Blanket Warmer

Before you begin

The warmer must be connected to electric power and turned on.



WARNING: Personal injury hazard.

Do not operate the warmer in the presence of a flammable anesthetic mixture with air, oxygen, or nitrous oxide; in oxygen-enriched environments; or in any other potentially explosive environment.



WARNING: Personal injury hazard.

Make sure the blanket support assembly and shelves are installed to prevent the blankets from being scorched or discolored.



Overloading or covering the sensor can potentially cause an error code and sensor may fail prematurely.

NOTICE

Do not overload the cavity. Allow 1" (25mm) between the blankets and the interior walls and 3" between the top of the blankets and the sensor.

Procedure

To operate the warmer, do the following.



Step	Action
1.	<p>Set the temperature in 5° increments using the Temperature Control Knob .</p> <p>The Temperature Display LED  will illuminate when the control is heating the unit.</p> <p>NOTE: The temperature set-point range is 60°F to 160°F (16°C to 71°C).</p>
2.	<p>Open the door and load the dry, cotton blankets into the warmer.</p> <p>Close the door.</p> <p>NOTICE Do not warm items containing plastic, rubber, metal snaps, studs, hooks, etc.</p>

Continued on next page

Continued from previous page

To toggle between Set and Actual Temperature

Factory default is to display Set Temperature in the screen. To toggle the screen between Set Temperature and Actual Temperature, do the following.

3. With the control ON, **press and hold** the Temperature Display Button  for 5 seconds. The screen will display "ACT", then show the Actual temperature.
4. Repeat to toggle to Set Point "SET".
5. **Press** the Temperature Display Button  at any time to display the alternate temperature.
6. **Rotate** the blankets daily from the bottom to the top of the load to ensure equal heating and to prevent discoloration.

Result

The blankets are now warming.



How to Change the Temperature Scale

Before you begin

The warmer must be connected to electric power.

To toggle between Fahrenheit and Celsius

The factory default is Fahrenheit. To change to Celsius, do the following.

Step	Action
1.	With the control OFF (i.e., The Temperature Control Knob  set to  OFF [vertical] position), press and hold the Temperature Display button  for 5 seconds.
2.	The screen will display "°C" for 3 seconds to verify selection and then display the temperature in °C.
3.	Repeat to toggle to Fahrenheit.

 **NOTE:** With a power failure, the control will retain the °C or °F setting selected by the user when power is restored.

Result

The temperature scale has now been changed.

How to Lock and Unlock the Controller

Before you begin

The warmer must be turned on (screen is on).

Background

The controller can be locked to prevent changes being made to the temperature set-point.

Locking the controller

To lock the controller, do the following.

Step	Action
1.	<p>Press the Control Lock button  and the Temperature Display button  at the same time.</p> <p>The Digital Display  will read "LOC".</p>
2.	<p>Press the Control Unlock button  and the Temperature Display button  at the same time. The controller is now unlocked and will adjust temperature to the current Temperature Control Knob  setting.</p> <p>NOTE: The Digital Display will not indicate the controller is unlocked.</p>

Unlocking the controller

To unlock the controller, do the following.



NOTE: The Digital Display will not indicate the controller is unlocked.

Result

The controller has now been locked or unlocked.

Maintenance Schedule



NOTE: Do not remove exterior panels from the warmer or attempt repairs. The warmer has no user-serviceable internal components. Only perform routine cleaning and maintenance procedures specifically described in this manual.

Daily

For daily maintenance, do the following.

Check:

- the air vents in the airflow insert panels are not obstructed (if applicable).
- all fan guards are clear and not obstructed (if applicable).
- the number of bottles/bags, or blankets as applicable do not exceed the maximum capacity per shelf or basket.

Clean:

- any spills with a clean, lint free cloth. See topic *How to Clean the Warmer* for the list of approved cleaners.
-

Monthly

For monthly maintenance, do the following.

Check:

- the door gasket for tears and holes. Make sure that it is firmly attached to the door. Check the seal when the door is closed.
- the guards around the air temperature sensor are in place and fully secure to the warmer.
- the hardware securing the warmer(s) to the wall, if applicable.

Clean:

- the outside of the warmer with stainless steel cleaner. See topic *How to Clean the Warmer* for the list of approved cleaners.
 - vacuum (if applicable):
 - fan openings
 - fan sail switch
 - vent openings
-

Continued on next page

MAINTENANCE

Continued from previous page

Yearly

For yearly maintenance, do the following.

Check:

- the set-point temperature compared to the actual temperature displayed.
 - Check the cavity air temperature with a thermocouple placed 1" (25mm) from the cavity sensor. Do not allow the thermocouple to touch any surface. Monitor the temperature for approximately one hour in an empty cavity.
- the condition of the plug and cord and replace if damaged.
- the controller screen for excessive wear. Make sure the controller screen displays and operates properly.

Clean:

- the shelves and interior of the warmer. See topic *How to Clean the Warmer* for the list of approved cleaners.

How to Clean the Warmer

Before you begin



WARNING: Electric shock hazard.
Disconnect the warmer from electric power before cleaning.



CAUTION: Burn hazard.
Allow the warmer to cool before cleaning.

NOTICE

- Do not use:
- abrasive cleaning compounds.
 - chloride based cleaners.
 - commercial or household cleaners containing ammonia.
 - cleaners containing quaternary salts.

Monthly cleaning procedure

To clean the warmer monthly, do the following.



Step	Action
1.	Make sure that the warmer is disconnected from electric power and cool.
2.	Wipe the outside of the warmer with a stainless-steel cleaner.
3.	Vacuum lint from fan openings, fan sail switch, and vent openings (if applicable).
4.	Clean the interior of the warmer with a damp cloth.
5.	Dry the interior and exterior of the warmer with a clean, lint-free cloth. Leave the door open until the interior of the warmer completely dries.
6.	Clean each side of the window pane with glass cleaner or distilled vinegar.

Continued on next page

Continued from previous page

Yearly cleaning procedure

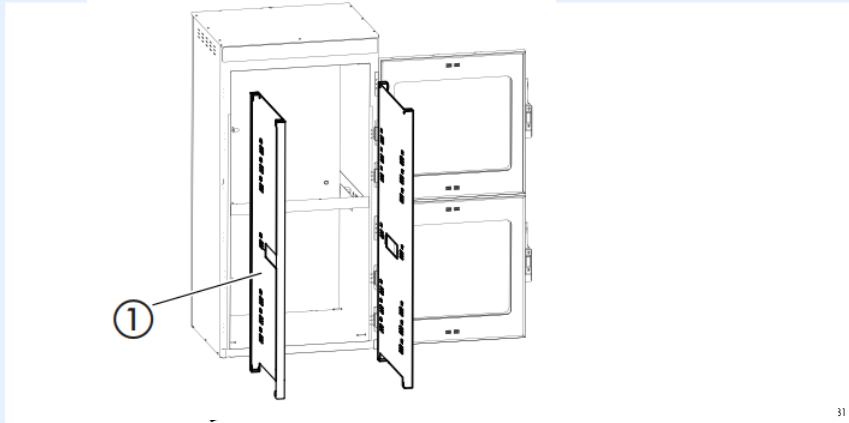
To clean the warmer yearly, do the following.

Step	Action
1.	Make sure that the warmer is disconnected from electric power and cool.
2.	Remove the shelves and support assembly G) from the interior of the warmer.
	
3.	Clean the support assembly and interior with a damp cloth.
4.	Dry the interior of the warmer with a clean, lint-free cloth. Leave the door open until the interior of the warmer completely dries.
5.	Clean each side of the window pane with glass cleaner or distilled vinegar.
6.	Re-install the support assembly.
<div style="display: flex; align-items: center;">  <div> <p>WARNING: Personal injury hazard.</p> <p>The blankets may overheat if the shelves and support assembly are not in place. Make sure to re-install the shelves and support assembly before operating the warmer.</p> </div> </div>	

Result

The warmer is now clean.

What to do if the Warmer Malfunctions

Background

The controller sounds an alarm and the screen displays an error code when the warmer malfunctions.

Procedure

If the warmer malfunctions, do the following.

Step	Action
1.	Rotate the Temperature Control Knob  to the OFF (vertical) position. Refer to the troubleshooting section for the error code.
2.	Make sure the blankets are the correct temperature before using.

Result

Resume operation of the warmer.

Error Codes

Background

This section is provided for the assistance of qualified and trained service technicians only and is not intended for use by untrained or unauthorized service personnel. Failure to observe this precaution may void the warranty.

The following error codes apply to the control. Where noted, the following apply:

Control Response	Description
Error beep	3 beeps every 10 seconds. Beeper can be turned off by pressing any button. Beeper turns off and the error display turns solid, the flashing stops. The alarm remains active. Reset per the table below.
Error flash	Approximately 0.8 seconds ON, 0.2 seconds OFF.
Temperature recall	For E-30 and E-31 error codes, pressing the Temperature Display button will display the temperature. For other error codes, the error code remains on the display.



NOTE: If the warmer is not operating properly, check the following before calling an authorized service agent:

Verify that the power to the warmer is on.

If applicable, ensure the female end of plug is securely seated in the warmer and that the male end of plug is in an appropriate, functioning outlet.

If applicable, examine the fuses. Replace the fuses, refer to topic *How to Replace a Fuse*.

If applicable, examine the high limit manual reset button. If the high limit manual reset button is tripped, reset the warmer,

NOTICE

Do not attempt to repair or service the warmer beyond this point. Contact the manufacturer for the nearest authorized service agent. Repairs made by any other service agent without prior authorization by the manufacturer will void the warranty.

Continued on next page

TROUBLESHOOTING

Continued from previous page

Error Display	Error Description	Error Definition Comments	Control Response	Reset
E-10	Sensor 0 shorted	Sensor short determined	Control: Relays OFF Display: Flash error code Beeper: Error beep	Auto-reset when sensor short resolved
E-11	Sensor 0 open	Resistance >3000 ohm (sensor not connected)	Control: Relays OFF Display: Flash error code Beeper: Error beep	Auto-reset when good probe is attached, i.e. valid reading
E-30	Under Temperature	25°F under Set Point Temperature for 90 minutes	Control: Function normal Display: Flash error code Beeper: Error beep	Auto-reset when temp rises above the Under Temp alarm condition
E-31	Over Temperature	OVEN: 60°F over max temp range for that model for 3 minutes	Control: Relays OFF Display: Flash error code Beeper: Error beep	Auto-reset when within 25°F of max temp range
E-32	Safety Switch Open (Aux Hi Limit Switch)	Designated models only. Aux Input open.	Control: Relays OFF Display: Flash error code Beeper: Error beep	Auto-reset when Aux Hi-Limit input closed
E-38	Internal software error	Internal Software error	Control: Relays OFF Display: Flash error code Beeper: Error beep	Call Factory
E-39	Sensor Error	Board level RTD temp circuit hardware error	Control: Relays OFF Display: Flash error code Beeper: Error beep	Call Factory
E-70	Configuration connector error (DIP-switch)	DIP-Switch error: not set to model or invalid model	Control: Relays OFF Display: Flash error code Beeper: Error beep	Correct DIP-switch. Turn control OFF, then ON
E-83	EEPROM error	Bad checksum	Control: Relays OFF Display: Flash error code Beeper: Error beep	Reset by performing CALIBRATION
E-90	Key Shorted	Any key >1 min shorted	Control: Relays OFF Display: Flash error code Beeper: Error beep	Rest when key no longer shorted
E-91	Input Failure	Internal Diagnostics	Control: Relays OFF Display: Flash error code Beeper: Error beep	Call Factory
EFAN (if equipped)	Fan Failure	Locked Fan Rotor detected. No signal on Aux 2 input	Control: Relays OFF Display: Flash error code Beeper: Error beep	Allow normal operation to resume when the locked rotor is cleared

Warranty

Introduction

Enthermics by Pedigo warrants to the original purchaser only, that any original part found to be defective in material or workmanship will, at our option, subject to provisions hereinafter stated, be replaced with a new or rebuilt part.

Warranty Period

The warranty period is as follows:

- For warming cabinets shipped to the United States or Canada,
 - The labor warranty remains in effect for one (1) year from installation or fifteen (15) months from the shipping date, whichever comes first. Enthermics by Pedigo will bear normal labor charges performed during the standard business hours, excluding overtime, holiday rates or any additional fees.
 - The original parts warranty remains in effect three (3) years from installation of appliance or thirty-nine (39) months from the shipping date, whichever comes first.
- For warming cabinets shipped outside of the United States or Canada,
 - The original parts warranty is one (1) year from the date of installation of appliance or fifteen (15) months from the shipping date, whichever comes first.
- To be valid, a warranty claim must be asserted during the applicable warranty period. This warranty is not transferable.

Exclusions

This warranty does not apply to:

- Calibration.
- Equipment damage caused by accident, shipping, improper installation or alteration.
- Equipment used under conditions of abuse, misuse, carelessness or abnormal conditions, including but not limited to, equipment subjected to harsh or inappropriate chemicals, including but not limited to, compounds containing chloride or quaternary salts, poor water quality, or equipment with missing or altered serial numbers.
- Any losses or damage resulting from malfunction, including the loss of contents or consequential or incidental damages of any kind.
- Equipment damage caused by use of any cleaning agents other than those recommended by Enthermics by Pedigo, including but not limited to damage due to chlorine or other harmful chemicals.
- Equipment modified in any manner from original model, substitution of parts other than factory authorized parts, unauthorized removal of any parts including legs, or unauthorized addition of any parts.

Continued on next page

WARRANTY

Continued from previous page

- Collateral or incidental damage as a direct result of servicing equipment built into a wall structure is not covered under warranty. It is the responsibility of the owner to bear all expense related structural repairs including, but not limited to, external electrical connections and wiring, and the removal or replacement of caulk, grout, tile, or wall covering of any kind. A service access panel for built-in equipment installations is strongly recommended.

Conclusion

This warranty is exclusive and is in lieu of all other warranties, expressed or implied, including the implied warranties of merchantability and fitness for a particular purpose. In no event shall the Company be liable for loss of use, loss of revenue, or loss of contents or revenue, or for indirect or consequential damages. This warranty is in lieu of all other warranties expressed or implied and Enthermics by Pedigo neither assumes nor authorizes any persons to assume for it any other obligation or liability in connection with Enthermics by Pedigo equipment.



Pedigo Products, Inc.

An ISO 13485:2016 certified company

4000 S.E. Columbia Way
Vancouver, WA 98661
360-695-3500

www.pedigo-usa.com

Made in the U.S.A