



trim mode  
**new!**

**WarmSafe™**  
technology

2024  
catalog



catalog download

# TABLE OF CONTENTS

## CARTS

• Revolution Case Carts.....	2-3
<b>new!</b> • GEN <sup>3</sup> Case Carts.....	4-5
• Sealed Case Carts.....	6-7
• CartSTAT.....	8
• Utility Carts.....	9
• Supply Carts.....	10
• Distribution Carts.....	11
• Multi-purpose Carts.....	12-13
• Accessories.....	14-15

## IV STANDS

• Stainless Steel.....	16
<b>new!</b> • Infusion Pump Stand.....	17-19
• Accessories.....	20-21
• Element.....	22-23

## NURSERY

• Bassinets.....	24-25
------------------	-------

## STANDS / KICKBUCKETS

• Mayo Stands.....	26-27
• Basin Stands.....	28
• Kick Buckets.....	29
<b>new!</b> • Hampers.....	30

## FOOTSTOOLS

• Footstools.....	31
-------------------	----

## SEATING

• Stools and Chairs.....	32-39
--------------------------	-------

## TABLES

• Space Station Two Tier Back Table.....	40-42
• Instrument Assembly Station.....	43
• Instrument Tables.....	44
• Utility Tables.....	45
• Central Supply Work Tables.....	46
• Over-Operating Tables.....	47

## WARMING CABINETS

• Blanket & Fluid Warmers.....	48-53
--------------------------------	-------

## MISCELLANEOUS

• Operating Room Cabinets & Wall Shelves.....	54-57
• Anesthesia and Treatment Cabinets.....	58
• Sterile Processing Equipment.....	59

## STRETCHERS

• 172 Basic Stretchers.....	60-61
-----------------------------	-------





**RCC-242-B**

**Overall outside dimensions:**  
46¼"W x 27½"D x 42½"H

**Usable Interior Space**  
37¼"W x 23¾"D x 27¾"H

Double door, with scratch and impact resistant clear polycarbonate windows; glass-filled polymer push handles on each end; CartStat biohazard indicator wheel; re • volve™ 6" diameter, maintenance-free, high-temp, engineered thermoplastic casters, two direction and two total lock casters.

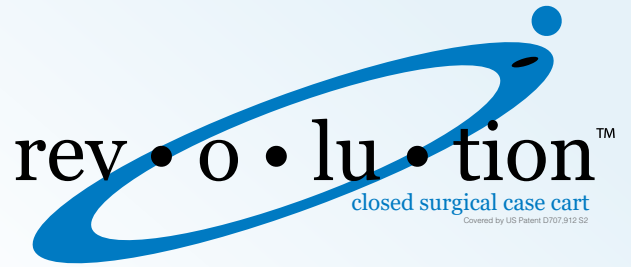

The **rev•o•lu•tion™** closed case cart is ergonomically designed to be lightweight and easy to handle, requiring less push/pull force than standard case carts.

**Design**

- Integrated body, floor and doors increases overall cart rigidity.
- Overall weight of cart reduced.
- Inside floor is sloped 1½° to the rear of cart to contain fluids.
- High temp, impact resistant bumper is mounted directly to the cart body to reduce overall footprint.
- Roll-out shelves with two position latch mechanism safely locks the shelf in or out.
- Cart is designed to quickly drain during cart washing to minimize residual water.



Biohazard Indicator Wheel  
**CartStat**

Adjustable Door Hinge  
For proper alignment.



Waterfall Wire Shelf



2 Total Lock Caster



Floor Sloped Toward Rear  
1½° slope for containment of fluid.



re • volve™ caster



**RCC-233-B**

Overall outside dimensions:  
29"W x 27½"D x 58½"H

Usable Interior Space  
20"W x 23¾"D x 44¾"H

Single door, with scratch and impact resistant clear polycarbonate windows; glass-filled polymer push handles on each end; CartStat biohazard indicator wheel; re • volve™ 6" diameter, maintenance-free, high-temp, engineered thermoplastic casters, two direction and two total lock casters.

**RCC-235-B**

Overall outside dimensions:  
36"W x 27½"D x 58½"H

Usable Interior Space  
27"W x 23¾"D x 44¾"H

Double door, with scratch and impact resistant clear polycarbonate windows; glass-filled polymer push handles on each end; CartStat biohazard indicator wheel; re • volve™ 6" diameter, maintenance-free, high-temp, engineered thermoplastic casters, two direction and two total lock casters.

**RCC-245-B**

Overall outside dimensions:  
46¼"W x 27½"D x 58½"H

Usable Interior Space  
37¼"W x 23¾"D x 44¾"H

Double door, with scratch and impact resistant clear polycarbonate windows; glass-filled polymer push handles on each end; CartStat biohazard indication wheel; re • volve™ 6" diameter, maintenance-free, high-temp, engineered thermoplastic casters, two direction and two total lock casters.

**RCC-256-MS-B**

Overall outside dimensions:  
29"W x 27½"D x 41½"H

Usable Interior Space  
20"W x 23¾"D x 27¾"H

Single door, with scratch and impact resistant clear polycarbonate window; glass-filled polymer push handles on each end; CartStat biohazard indicator wheel; re • volve™ 6" diameter, maintenance-free, high-temp, engineered thermoplastic casters, two direction and two total lock casters.

---

### Shelving Configurations

**RCC-333-WS**..... Wire shelf, for RCC-233-B and RCC-256-MS-B.

**RCC-333-SS**..... Solid shelf, for RCC-233-B and RCC-256-MS-B.

**RCC-333-WSRO** .. Roll-out wire shelf, with (2) position spring loaded shelf lock. Shelf locks in storage and fully extended position for RCC-233-B and RCC-256-MS-B.

**RCC-333-SSRO** ... Roll-out solid shelf, with (2) position spring loaded shelf lock. Shelf locks in storage and fully extended position for RCC-233-B and RCC-256-MS-B.

**RCC-335-WS**..... Wire shelf, for RCC-235-B.

**RCC-335-SS**..... Solid shelf, for RCC-235-B.

**RCC-335-WSRO** .. Roll-out wire shelf, with (2) position spring loaded shelf lock. Shelf locks in storage and fully extended position, for RCC-235-B.

**RCC-335-SSRO** ... Roll-out solid shelf, with (2) position spring loaded shelf lock. Shelf locks in storage and fully extended position, for RCC-235-B.

**RCC-342-WS**..... Wire shelf, for RCC-242-B and RCC-245-B.

**RCC-342-SS**..... Solid shelf, for RCC-242-B and RCC-245-B.

**RCC-342-WSRO** .. Roll-out wire shelf, with (2) position spring loaded shelf lock. Shelf locks in storage and fully extended position, for RCC-242-B and RCC-245-B.

**RCC-342-SSRO** ... Roll-out solid shelf, with (2) position spring loaded shelf lock. Shelf locks in storage and fully extended position, for RCC-242-B and RCC-245-B.



**new!**

# gen3

surgical case carts



CDS-356-LD shown with optional shelf

### CDS-356-LD-B

Overall outside dimensions:  
29½"W x 28⅛"D x 39"H

Usable Interior Space  
20"W x 24¼"D x 27¼"H

*One shelf configuration recommended*



CDS-356-MS shown with optional shelf

### CDS-356-MS-B

Overall outside dimensions:  
29½"W x 28"D x 39"H

Usable Interior Space  
20"W x 24¼"D x 27¼"H

*One shelf configuration recommended*

## case carts

surgical

### features

- Stainless steel construction.
- Integrated body and floor increases overall cart rigidity.
- High temp, impact resistant bumper mounted directly to cart body reducing the overall footprint.
- Cool-Touch polymer handle.
- 6" diameter stainless steel casters.
- Biohazard Indicator Wheel standard.
- CDS-342 and CDS-345 feature two direction lock casters.
- Roll-out shelves with two position latch mechanism safely locks the shelf in or out.
- Cart is designed to quickly drain during cart washing to minimize residual water.



Cool-Touch Handle



Biohazard Indicator Wheel  
**CartStat**



Modular Bumper



Waterfall Wire Shelf



**re•volve™**  
caster upgrade



CDS-335 shown with optional shelves

**CDS-333-B**

Overall outside dimensions:  
29½"W x 28"D x 56"H

Usable Interior Space  
20"W x 24¼"D x 44¼"H

*Two shelf configuration recommended*

**CDS-335-B**

Overall outside dimensions:  
35"W x 32¾"D x 56"H

Usable Interior Space  
25½"W x 29"D x 44.¼"H

*Two shelf configuration recommended*

**CDS-342-B**

Overall outside dimensions:  
46¾"W x 28"D x 39"H

Usable Interior Space  
37½"W x 24¼"D x 27"H

*One shelf configuration recommended*

**CDS-345-B**

Overall outside dimensions:  
46¾"W x 28"D x 56"H

Usable Interior Space  
37½"W x 24¼"D x 44¼"H

*Two shelf configuration recommended*

**Shelving Configurations**

**CDS-333-SS** ..... Stainless steel solid shelf for CDS-333, CDS-356-LD and CDS-356-MS.

**CDS-333-SSRO** ... Stainless steel roll-out solid shelf for CDS-333, CDS-356-LD and CDS-356-MS.

**CDS-333-WS** ..... Stainless steel wire shelf for CDS-333, CDS-356-LD and CDS-356-MS.

**CDS-333-WSRO** .. Stainless steel roll-out wire shelf for CDS-333, CDS-356-LD and CDS-356-MS.

**CDS-335-SS** ..... Stainless steel solid shelf for CDS-335.

**CDS-335-SSRO** ... Stainless steel roll-out solid shelf for CDS-335.

**CDS-335-WS** ..... Stainless steel wire shelf for CDS-335.

**CDS-335-WSRO** .. Stainless steel roll-out wire shelf for CDS-335.

**CDS-342-SS** ..... Stainless steel solid shelf for CDS-342 and CDS-345.

**CDS-342-SSRO** ... Stainless steel roll-out solid shelf for CDS-342 and CDS-345.

**CDS-342-WS** ..... Stainless steel wire shelf for CDS-342 and CDS-345.

**CDS-342-WSRO** .. Stainless steel roll-out wire shelf for CDS-342 and CDS-345.

Custom CDS carts engineered to customer specifications available upon request.



SCC-256-MS shown with optional drop leaf

### SCC-256-MS

Overall outside dimensions:

28<sup>5</sup>/<sub>8</sub>"W x 28<sup>5</sup>/<sub>8</sub>"D x 39<sup>7</sup>/<sub>8</sub>"H

Usable Interior Space

20<sup>1</sup>/<sub>4</sub>"W x 24"D x 26<sup>1</sup>/<sub>4</sub>"H

*One shelf configuration recommended*

## sealed carts

surgical

### features

Sealed Case Carts features a full seal around the door perimeter and center stop providing an added level of protection against dust and debris.

- Fully-welded all stainless steel construction
- Exterior push handles for better control and more interior space
- One-piece continuous wrap-around bumper, non-marring
- Sound-deadened tops and doors for quiet operation
- Positive lock door latches
- All carts can be manufactured to individual specifications



Biohazard Indicator Wheel  
**CartStat**



Sealed Case Cart Option



Heavy Duty Casters  
*Option*



Floor Sloped Toward Rear  
2° slope for containment of fluid.



Total Lock Brake  
*Option*



SCC-235 shown with optional shelves & CartStat



SCC-242 shown with optional shelf



SCC-245 shown with optional shelves

**SCC-233**

Overall outside dimensions:  
28<sup>5</sup>/<sub>8</sub>"W x 28<sup>5</sup>/<sub>8</sub>"D x 56<sup>7</sup>/<sub>8</sub>"H

Usable Interior Space  
20<sup>1</sup>/<sub>4</sub>"W x 24"D x 43<sup>1</sup>/<sub>4</sub>"H

*Two shelf configuration recommended*

**SCC-235**

Overall outside dimensions:  
34<sup>1</sup>/<sub>8</sub>"W x 32<sup>3</sup>/<sub>8</sub>"D x 56<sup>7</sup>/<sub>8</sub>"H

Usable Interior Space  
25<sup>3</sup>/<sub>4</sub>"W x 27<sup>3</sup>/<sub>4</sub>" x 43<sup>1</sup>/<sub>4</sub>"H

*Two shelf configuration recommended*

**SCC-242**

Overall outside dimensions:  
45<sup>7</sup>/<sub>8</sub>"W x 28<sup>5</sup>/<sub>8</sub>"D x 39<sup>7</sup>/<sub>8</sub>"H

Usable Interior Space  
37<sup>1</sup>/<sub>2</sub>"W x 24"D x 26<sup>1</sup>/<sub>4</sub>"H

*One shelf configuration recommended*

**SCC-245**

Overall outside dimensions:  
45<sup>7</sup>/<sub>8</sub>"W x 28<sup>5</sup>/<sub>8</sub>"D x 56<sup>7</sup>/<sub>8</sub>"H

Usable Interior Space  
37<sup>1</sup>/<sub>2</sub>"W x 24"D x 43<sup>1</sup>/<sub>4</sub>"H

*Two shelf configuration recommended*

**OPTIONAL FEATURES**

- Security Latch
- Barcode Plate Holder
- Heavy Duty 6" x 2" Casters
- 8<sup>1</sup>/<sub>2</sub>" x 11" Card Holder
- Color Identification Wheel

**Shelving Configurations**

**CDS-233-SS** ..... Stainless steel solid shelf for CDS-233, CDS-256-LD and CDS-256-MS.

**CDS-233-SSRO** ... Stainless steel roll-out solid shelf for CDS-233, CDS-256-LD and CDS-256-MS.

**CDS-233-WS** ..... Stainless steel wire shelf for CDS-233, CDS-256-LD and CDS-256-MS.

**CDS-233-WSRO** .. Stainless steel roll-out wire shelf for CDS-233, CDS-256-LD and CDS-256-MS.

**CDS-235-SS** ..... Stainless steel solid shelf for CDS-235.

**CDS-235-SSRO** ... Stainless steel roll-out solid shelf for CDS-235.

**CDS-235-WS** ..... Stainless steel wire shelf for CDS-235.

**CDS-235-WSRO** .. Stainless steel roll-out wire shelf for CDS-235.

**CDS-242-SS** ..... Stainless steel solid shelf for CDS-242 and CDS-245.

**CDS-242-SSRO** ... Stainless steel roll-out solid shelf for CDS-242 and CDS-245.

**CDS-242-WS** ..... Stainless steel wire shelf for CDS-242 and CDS-245.

**CDS-242-WSRO** .. Stainless steel roll-out wire shelf for CDS-242 and CDS-245.

Custom SCC carts engineered to customer specifications available upon request.





# CartStat

Ensure safe transport and compliance

- Designed for compliance with OSHA standard CFR 1910.1030, ANSI/AAMI ST 79.
- Clearly communicate the contents and destination of the cart - supports staff safety and sterility.
- **CartStat** wheel mounts directly on the cart so you always provide safe transportation of instruments.

**Options:**

Biohazard Indicators

- RCC-BH
- CDS-BH



**CartStat**

Clearly communicate the contents and destination of the cart - supports staff safety and sterility. Designed for compliance with OSHA standard CFR 1910.1030, ANSI/AAMI ST 79.

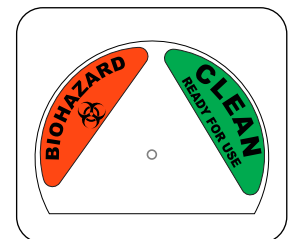

Biohazard Indicator Wheel



# utility carts

### features

- Stainless steel, Steril-Gard construction
- Easy to clean
- Strong, fully welded construction



### CDS-145 Utility Cart

#### OVERALL SIZE

41½"W x 23¾"D x 38¼"H

#### SHELF WEIGHT CAPACITY

Top 50 lbs.  
Middle 50 lbs.  
Bottom 100 lbs.

**Maximum Load 200 lbs.**

5" chrome plated casters



### CDS-140 Light Weight Utility Cart

#### OVERALL SIZE

27½"W x 18½"D x 40"H

#### SHELF WEIGHT CAPACITY

Top 25 lbs.  
Middle 25 lbs.  
Bottom 50 lbs.

**Maximum Load 100 lbs.**

4" chrome plated casters



### CDS-140-B Light Weight Utility Cart

#### OVERALL SIZE

32"W x 21¼"D x 40"H

#### SHELF WEIGHT CAPACITY

Top 25 lbs.  
Middle 25 lbs.  
Bottom 50 lbs.

**Maximum Load 100 lbs.**

4" chrome plated casters  
5" rolling bumpers



Cart shown with optional linen rings

### CDS-153-HD Heavy-Duty Utility Cart

#### OVERALL SIZE

39¾"W x 27¾"D x 44¾"H

#### SHELF WEIGHT CAPACITY

Top 250 lbs.  
Middle 250 lbs.  
Bottom 400 lbs.

**Maximum Load 900 lbs.**

6" chrome plated casters  
optional brake casters available



Cart shown with optional accessories

### **CDS-177** Central Supply Cart

#### **Overall Size**

55<sup>3</sup>/<sub>8</sub>"W x 26<sup>1</sup>/<sub>8</sub>"D x 58"H

Includes seven standard 5" deep tote boxes or up to three large 10" deep tote boxes



Cart shown with optional accessories

### **CDS-178** Central Supply Cart

#### **Overall Size**

66<sup>5</sup>/<sub>8</sub>"W x 26<sup>1</sup>/<sub>8</sub>"D x 69"H

Includes nine standard 5" deep tote boxes or up to four large 10" deep tote boxes

## supply carts

#### **features**

- All welded stainless steel construction for one single piece frame
- Outboard plate-mounted 8" chrome plated casters with diagonally mounted swivel locks provide stability
- Wrap around bumper mounted away from frame for easy cleaning
- Optional shelves and accessories available to configure the cart to suit individual needs

# distribution carts



Cart shown with optional accessories

## features

- All welded stainless steel construction
- All seams fully welded
- Frame tubing is 1 1/4" - 18 gauge stainless steel
- Wrap around bumper mounted away from the frame for easy cleaning
- Shelves adjust every four inches
- Low maintenance
- Solid stainless steel pan bottom with reinforcing channel and sound control strip for added strength and quiet operation

## CDS-147 distribution Cart

### OVERALL SIZE

39 3/8"W x 26 1/8"D x 42 1/8"H

- Ideal for case cart systems or general floor use
- Shelf size 35 1/4"W x 20 3/8"D
- 5" chrome plated swivel casters



CDS-147-A  
Swivel Caster



Cart shown with optional accessories

## CDS-148 distribution Cart

### OVERALL SIZE

50 5/8"W x 26 1/8"D x 58"H

- Suitable for general floor service, pharmacy or linen
- Shelf size 46 3/8"W x 20 3/8"D
- 8" chrome plated casters with two diagonally mounted swivel locks



Cart shown with optional accessories

## CDS-149 distribution Cart

### OVERALL SIZE

60 3/8"W x 26 1/8"D x 67"H

- Ideal cart for linen distribution, storage and floor nursing stations
- Shelf size 55 3/4"W x 20 3/8"D
- 8" chrome plated casters with two diagonally mounted swivel locks

## Accessories

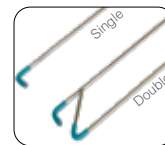

Retaining Rods  
(adjustable)

- Single style
- Double style



Tote Boxes  
(two way)

- 5" deep
- 10" deep



Shelf Dividers  
(adjustable)

- 6" tall
- 10" tall



Wire Backs

- 2" x 3" openings
- 4" x 6" openings

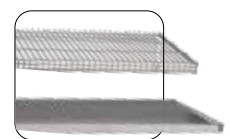

Stainless Steel Shelves

- Wire shelf
- Solid shelf





### CDS-153 Cart

#### Overall Size

36½"W x 26¾"D x 35½"H

- Optional linen rings to hold hamper or trash bags
- Linen ring locks in up position and swings down when not in use
- Equipped with rails on the all three surfaces
- Adjustable stainless steel center shelf
- 5"- diameter chrome plated swivel casters

## multi-purpose carts

### features

- All welded stainless steel construction for one single piece frame
- 5" chrome plated casters with diagonally mounted swivel locks provide stability
- Wrap around bumper mounted away from frame for easy cleaning
- Optional shelves and accessories available to configure the cart to suit individual needs



Swivel Plate Caster



Cart shown with optional ring



shown with optional accessories

### CDS-270 Cart

#### Overall Size

50<sup>5</sup>/<sub>8</sub>"W x 26<sup>1</sup>/<sub>8</sub>"D x 65"H

- Designed to be used as a clean/dirty linen cart or as a large utility cart
- May be ordered with optional shelves, wire backs, and other accessories

## multi-purpose carts

#### features

- All welded stainless steel construction for one single piece frame
- 6" chrome plated casters with diagonally mounted swivel locks provide stability
- Wrap around bumper mounted away from frame for easy cleaning
- Optional shelves and accessories available to configure the cart to suit individual needs



Swivel Plate Caster



Cart shown with optional accessories

### CDS-262 Multi Use Procedure Cart

#### Overall Size

29<sup>5</sup>/<sub>8</sub>"W x 29<sup>5</sup>/<sub>8</sub>"D x 62<sup>3</sup>/<sub>8</sub>"H

- Designed to be used as a surgical or obstetrical case cart
- Multi-purpose cart can also be used as a linen cart or as a clean/dirty utility cart
- May be ordered with optional shelves, wire backs, and other accessories

# open cart accessories



## Shelf Dividers

- Adjustable
- Stainless steel construction for durability and ease of maintenance
- Available for solid or wire shelves in 6" or 10" height

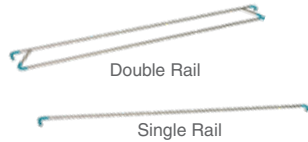

## Retaining Rails

- Retaining rails to prevent accidental loss of materials
- Easily attached or removed
- Sound deadening rubber sleeve
- Polished stainless steel ( $\frac{5}{16}$ " diameter)



## Wire Shelves

- Electro-polished stainless steel
- Easy to adjust or remove
- $\frac{3}{16}$ " diameter wire welded to  $\frac{1}{4}$ " diameter wire support rods
- Maximum opening between rods: 1" x  $8\frac{3}{4}$ "



## Solid Shelves

- Steril-Gard construction
- Easy to adjust or remove
- 18-gauge stainless steel



## 5" Tote Box Drawers

- Constructed of impact-resistant, high-density polyethylene for durability
- Optional short or long tote box dividers available

### DIMENSIONS:

17 $\frac{3}{4}$ "L x 14 $\frac{1}{2}$ "W x 51/8"D



Tote mounted with hanger

## 10" Tote Box Drawers

- Constructed of impact-resistant, high-density polyethylene for durability
- Optional short or long tote box dividers available

### DIMENSIONS:

17 $\frac{3}{4}$ "L x 14 $\frac{1}{2}$ "W x 10"D

### Tote Box Hangers

- Hangs below both wire or solid shelving



Stainless Steel Caster

## Stainless Steel Casters

- Recommended for carts that are cart washed
- All stainless steel material and bearings for a rust-free caster
- Two lubrication points for ease of maintenance



Swivel Lock

## Swivel Lock

- Used for improved steering
- Recommended for long carts to assist in navigating long corridors
- Disengage swivel lock for maneuverability in tight spaces
- Easy foot operation



## Automatic Couplers

- Cart couplers are available for installation on all open carts
- Compatible with any major elevator or cart washer with automatic cart pickup system



## Disposable Cart Covers

- Heavy, clear plastic material
- Can serve as a trash bag after completion of the procedure
- Packed on convenient rolls
- Economical, single-use alternative to washable covers



## Heavy-Duty Covers

- Heavy duty, anti-bacterial STAPH-CHEK™ covers protect cart and its cargo
- Flame-resistant
- Clear vinyl front with heavy-duty nylon zippers or Velcro closures
- Hand clean with soap and warm water ONLY. Do not launder.



## Wire Backs

- Electro-polished stainless steel
- $\frac{3}{16}$ " diameter vertical wires, welded to  $\frac{1}{4}$ " diameter horizontal rods
- Choice of 2" x 3" or 4" x 6" openings

# closed cart accessories



Safety Release Leaf Lock Button

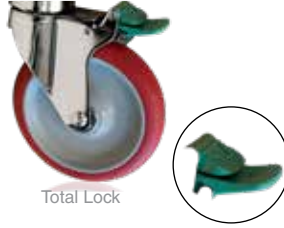

Total Lock



Swivel Lock



Stainless Steel Caster

## Drop Leaf Shelves

- Extends top of cart to increase work surface area
- Drain holes at end of leaf
- Features Safety Release Leaf Lock Button

## High Temp Caster

- Maintenance-free caster
- Recommended for high temp cart wash environments
- Precision sealed stainless steel swivel & wheel bearings
- High-temp rubber tread donut shaped wheel

## Swivel Lock

- Used for improved steering
- Recommended for long carts to assist in navigating long corridors
- Disengage swivel lock for maneuverability in tight spaces
- Easy foot operation

## Stainless Steel Casters

- Recommended for high temp cart wash environments
- All stainless steel material and bearings for a rust-free caster
- Two lubrication points for ease of maintenance



## Automatic Couplers

- Cart couplers are available for installation on all closed carts
- Compatible with any major elevator or cart washer with automatic cart pick up system

## Wire Shelves

- Stainless steel
- Easy to adjust or remove
- $\frac{3}{16}$ " diameter wire welded to  $\frac{5}{16}$ " diameter wire support rods
- Maximum opening between rods:  $1\frac{5}{16}$ " x  $7\frac{11}{16}$ "

## Solid Shelves

- Steril-Gard construction
- Easy to adjust or remove
- 18-gauge stainless steel

## Card Holder

- Standard card sizes include:
  - 4" x 6"
  - 5" x 7"
  - 8½" x 11"
- Available in any size or orientation to suit individual needs

## Cart ID Systems

- For easy cart identification
- High-visibility Lexan material
- Cart washable
- Custom labels available upon request ( $\frac{5}{16}$ " diameter)



\* Tote boxes are not cart wash compatible.

## CartStat

- **CartStat** wheel mounts directly on the cart so you always provide safe transportation of instruments.
- Designed for compliance with OSHA standard CFR 1910.1030, ANSI/AAMI ST 79.
- May be mounted in the field.

## Exterior Security Latch

- Prevents unintentional opening of cart doors
- Available with hole to fit customer provided tamper proof tags



Tamper Proof Tag

## Security Paddle Latch

- Easy to add in field - no drilling required
- Flush mount - does not extend beyond door face
- Integrated to paddle latch

## Tote Box Drawers

- Constructed of impact-resistant high density polyethylene for durability
- Available in 5" or 10" sizes
- Optional short or long tote box dividers available to section drawer into smaller compartments

## Tote Box Hangers

- Stainless steel hangers hold totes below top of the cart
- Attaches to either wire or solid shelving



### P-1572-4 four hook

- Hand operated, friction lock height adjustment
- Height adjustable from 68½" to 117½"
- Five leg base
- 70 lbs. overall weight capacity
- 10 lbs. per hook (recommended 30 lbs. max. evenly distributed on top hooks for stability)

#### Safe Load Capacity

For stability, a safe load on this series I.V. pole should not exceed 40 lbs. to one side and needs to be within 6" of base tube center line.

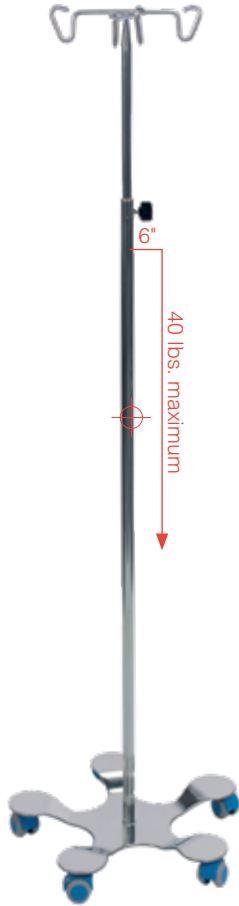

## iv stands

### features

- Stainless steel
- Heavy, tip-resistant, all welded design
- 2" swivel dual-wheel casters for easy
- 21¼" diameter base on all stands mobility
- Tube: O.D. = 1"
- Easy to clean surfaces

### clearview technology™

- For the easy reading of all IV bag labels from the front of the stand.
- Hooks are ideal for IV piggybacking of primary and secondary bags.

 clearview technology™



### P-1572-CV six hook

- Hand operated, friction lock height adjustment
- Height adjustable from 69½" to 119"
- Five leg base
- 70 lbs. overall weight capacity
- 7 lbs. per hook (recommended 30 lbs. max. evenly distributed on top hooks for stability)

### P-1576-4 four hook

- Quick and easy one-hand foot pedal height adjustment
- Height adjustable from 68½" to 117½"
- 70 lbs. overall weight capacity
- 10 lbs. per hook (recommended 30 lbs. max. evenly distributed on top hooks for stability)

 clearview technology™

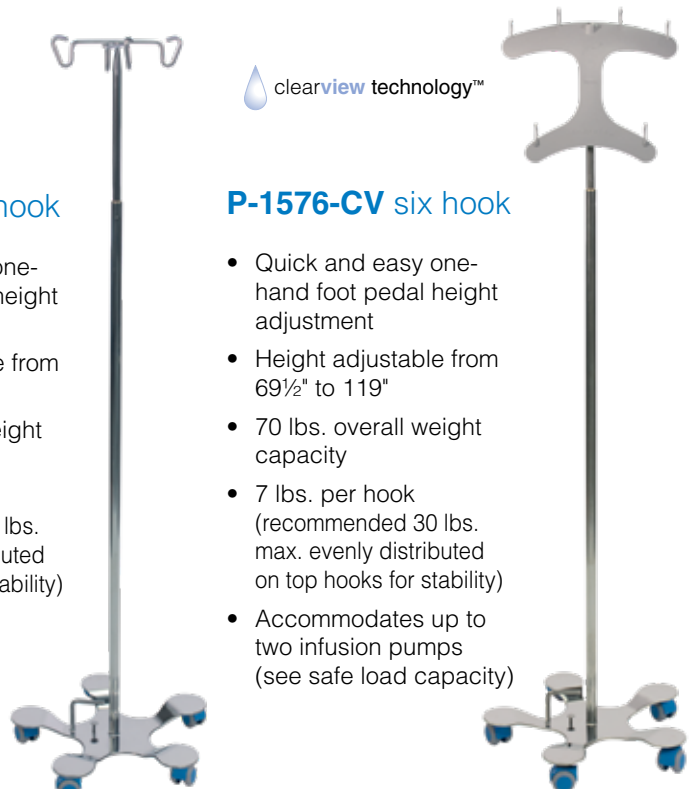

### P-1576-CV six hook

- Quick and easy one-hand foot pedal height adjustment
- Height adjustable from 69½" to 119"
- 70 lbs. overall weight capacity
- 7 lbs. per hook (recommended 30 lbs. max. evenly distributed on top hooks for stability)
- Accommodates up to two infusion pumps (see safe load capacity)

**new!**

Height adjustable  
from 70" to 120"

### P-1095-8 eight hook

- Hand operated, friction lock height adjustment
- Height adjustable from 70" to 120"
- Five leg base
- 95 lbs. overall weight capacity
- 10 lbs. per hook (recommended 30 lbs. max. evenly distributed on top hooks for stability)

#### Safe Load Capacity

For stability, a safe load on this series stand should not exceed 75 lbs. within 6" off center.

- 95 lbs max total pumps and bags.



## infusion pump stand

### features

- Bag Drop Prevention Device allows for controlled descent of pole.
- Stainless steel IV hook assembly features eight hooks.
- Heavy duty 3" sealed casters with precision ball bearings.
- Powder-coated 30 lbs. steel base.
- Pole sleeve welded securely to the base for reinforced stability.

**Pink**  
pole™

infusion pump stand



Option - Handle & Tray Insert



Heavy-Duty 30 lbs. Base  
26" Diameter



Offset Post

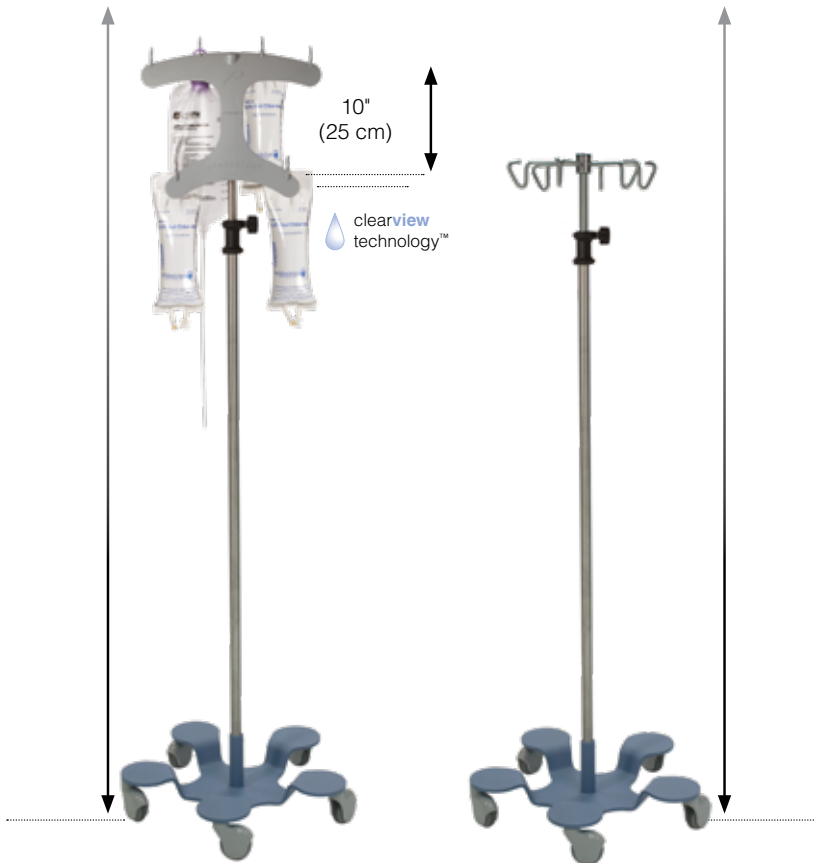

**P-1080-CV**  
Height adjustable  
from 71" to 124"

**P-1080-6**  
Height adjustable  
from 72½" to 124"



**P-1083-CV**  
Height adjustable  
from 71" to 124"

**P-1083-6**  
Height adjustable  
from 72½" to 124"

# infusion pump stand

## common features

- Bag Drop Prevention Device allows for controlled descent of pole.
- Heavy duty 3" (8cm) sealed casters with precision ball bearings.
- Extremely durable powder coat finish base.
- Low center of gravity design and 27 lbs. base offers improved stability
- Pole sleeve welded securely to the base for reinforced stability.
- Small 23" (58cm) base reduces stumbles and falls while patient ambulates.
- Hand operated easygrip™ knob.

## P-1080-CV

- High impact molded polymer IV hook assembly features six hooks.

## P-1080-6

- Six stainless steel IV hooks

## P-1083-CV

- High impact molded polymer IV hook assembly features six hooks.
- Pole made from copper nickel alloy.

## P-1083-6

- Pole made from copper nickel alloy.
- Six stainless steel IV hooks



### Pole

Stainless steel resists staining, corrosion and rusting.

### Stainless Steel Base

Low center of gravity design and 27 lbs. base offers improved stability.

### 23" Diameter Base

Small base reduces stumbles and falls while patient ambulates.

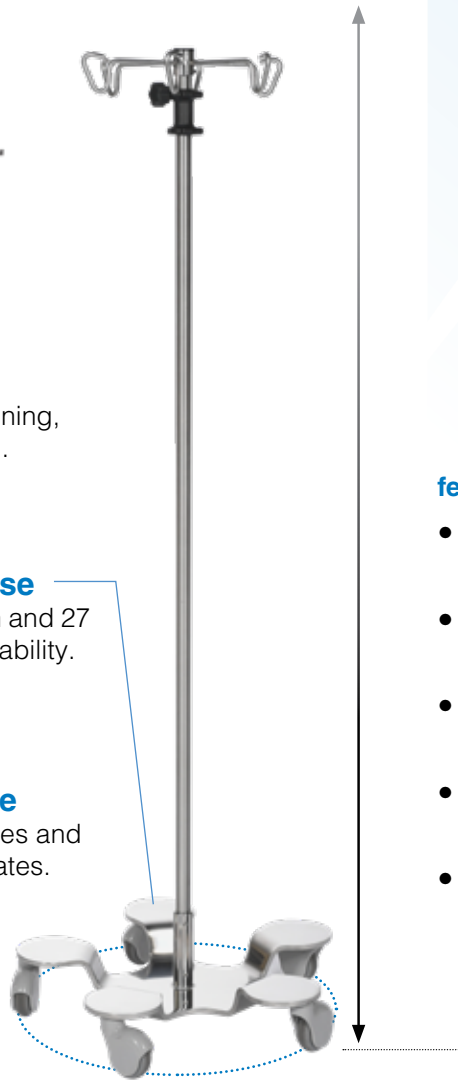

Height adjustable from 70½" to 124"

# P-1080-SS

## infusion pump stand

### features

- Bag Drop Prevention Device allows for controlled descent of pole.
- Stainless steel IV hook assembly features six hooks.
- Heavy duty 3" (8cm) sealed casters with precision ball bearings.
- Corrosion resistant all stainless steel base.
- Pole sleeve welded securely to the base for reinforced stability.



Stainless base



# infusion pump accessories



### PATIENT HANDLE

Adjustable handle provides easy mobility.

- P-3305 Stainless Steel
- P-3306 Copper nickel alloy
- P-3307 Black
- P-3305-T Tray Insert



### CV HOOK

Molded polymer six hook IV assembly

- P-1090-CV-TH Assembly

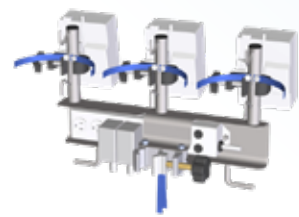

### INFUSION PUMP HOLDER

Holds up to 3 pumps

- P-1080-G Infusion Pump Holder



### 8-HOOK ASSEMBLY

Extended IV Hook Assembly

- P-1080-H Stainless Steel



### IV SET ORGANIZER

Also holds secondary bags

- P-1080-B Stainless Steel



### S'MORE HOOK

For mounting additional IV bags

- P-1080-J Stainless Steel

# infusion pump accessories



## WIRE BASKET

P-3201 Large (Stainless)  
P-3202 Large (Black)  
P-3211 Med (Stainless)  
P-3212 Med Black



## FOLEY HOOK

P-1080-D Foley 2 Hooks  
P-1080-E Foley 1 Hook  
*(Factory installed)*



## O<sub>2</sub> HOLDER

Holds E-size oxygen tanks  
P-3601 Stainless Steel



## OUTLET STRIP

Hospital grade  
P-3401 Six outlet strip



## INFUSION PUMP HOOP

Holds up to 6 pumps  
P-1080-F Stainless Steel  
P-1083-F Copper nickel alloy



## MULTIPLE PUMP HOLDER

Infusion pump holder  
P-1080-C Stainless Steel  
P-1083-C Copper nickel alloy





### features

Pedigo's new IV stand features a number of unique design elements to further promote safety, organization and efficiency of IV fluid administration.



#### clearview technology™

High impact molded polymer IV hook assembly features six hooks for easy reading all IV bag labels from the front of the stand.

Built-in offset for IV piggybacking.

Smooth finish and easy to clean.



#### clearstep technology™

Created with patient and staff safety in mind, the element's clearstep base is ergonomically designed for easy ambulation.



#### interlockingbases™

The interlockingbases™ allow for multiple stands to be moved at one time by connecting the element™ together.

Designed for comfortable transport and storage of multiple stands.





### Adjustment

Hand operated easygrip™ knob.

### Pole

Stainless steel resists staining, corrosion and rusting.

### Base

Five caster, 19 lbs. (9 kg) base offers improved stability.

### Casters

Precision ball bearing sealed casters for ultra low rolling resistance.

### Footprint - 21.25 (54 cm)

Small footprint allows unobstructed path while patient ambulates.

P-1090-CV Infusion Pump Stand

## SPECIFICATIONS

element™

**P-1090-CV**

### Weight

Overall Product Weight	26 lbs. (12 kg)
Base Weight (with Casters)	19 lbs. (9 kg)

### Weight Capacity (Maximum)

Hooks (each)	7 lbs. (3 kg)
Offset Load (Base Tube)†	40 lbs. (18 kg)
Total Load‡	90 lbs. (41 kg)
Number of Pumps per Stand	4 (10 lbs. each)

### Casters

5 Swivel Casters	3" (8 cm)
------------------	-----------

### Height Adjustment

Low	74" (188 cm)
High	122" (310 cm)

Base Diameter (Caster Centerline)	21.25" (54 cm)
-----------------------------------	----------------

Number of Interlocking Stands (Max.) 6

### Accessories

Patient Handle	O <sub>2</sub> Holder	Basket
Outlet Strip	Foley bag Hook	

† 40 lbs max applied at 6" off center, 3 ft off ground

‡ 90 lbs max applied at centerline of pole, 3 ft off ground



The clearview™ hooks are ideal for IV piggybacking of primary and secondary bags with a full 10" of height difference between bags.



With a recess on each side of the base, emulating the natural shape of the foot, clearstep™ allows for safe ambulation.





shown with optional bassinet and pad

**P-1110-B-SS**  
bassinet stand with drawer

**new!**  
**co-re  
caster™**

## bassinet

### P-1110-B-SS features

- Side mounted drawer measures: 16½"W x 21¼"L x 3⅛"H
- Design allows close approach from both sides
- Basket can be raised at either end
- 3" double ball bearing swivel casters

### frame size

18¼"W x 31"L x 37¾"H  
(Height with bassinet basket: 41"H)



shown with optional bassinet and pad

**P-1110-SS**  
bassinet stand

### features

- Design allows close approach from both sides
- Basket can be raised at either end
- 3" double ball bearing swivel casters

### frame size

- 18¼"W x 31"L x 37¾"H
- Height with bassinet basket: 41"H



shown with optional bassinet and pad

**P-1110-A-SS**  
bassinet stand with drawer

### features

- End mounted drawer measures: 16½"W x 13¼"L x 7⅜"H
- Design allows close approach from both sides
- Basket can be raised at either end
- 3" double ball bearing swivel casters

### frame size

- 18¼"W x 31"L x 37¾"H
- Height with bassinet basket: 41"H



shown with optional bassinet and pad

### P-1115-A-SS

bassinet cabinet

#### features

- Bassinet carriage slides back to allow working area
- Friction lock secures the bassinet in both open and closed positions
- Removable internal shelf, positioned in middle left compartment
- 4" double ball bearing swivel casters

#### dimensions

19<sup>3</sup>/<sub>4</sub>"W x 30<sup>7</sup>/<sub>8</sub>"L x 37<sup>1</sup>/<sub>4</sub>"H

- Height with bassinet 44<sup>1</sup>/<sub>8</sub>"

#### cabinet dimensions

- 17"W x 29<sup>1</sup>/<sub>2</sub>"L x 24<sup>7</sup>/<sub>8</sub>"H

#### drawer frame with removable pan

- 11<sup>1</sup>/<sub>4</sub>"W x 16<sup>1</sup>/<sub>2</sub>"L x 4"H



shown with optional bassinet and pad

### P-1115-SS

bassinet cabinet

#### features

- Bassinet carriage slides back to allow working area
- Friction lock secures the bassinet in both open and closed positions
- Removable internal shelf, positioned in middle left compartment
- 4" double ball bearing swivel casters

#### dimensions

19<sup>3</sup>/<sub>4</sub>"W x 30<sup>7</sup>/<sub>8</sub>"L x 37<sup>1</sup>/<sub>4</sub>"H

- Height with bassinet 44<sup>1</sup>/<sub>8</sub>"

#### cabinet dimensions

- 17"W x 29<sup>1</sup>/<sub>2</sub>"L x 24<sup>7</sup>/<sub>8</sub>"H

#### drawer frame with removable pan

- 11<sup>1</sup>/<sub>4</sub>"W x 16<sup>1</sup>/<sub>2</sub>"L x 4"H



### ST-1833-SS

pediatric scale table

#### features

- Designed for use with common electronic scales
- Oversize 4" casters for easy movement
- One brake caster for stability

#### dimensions

33"W x 18"D x 35<sup>1</sup>/<sub>2</sub>"H

## OPTIONS



Part No. 53  
Bassinet Basket

#### basket measures

16"W x 30<sup>1</sup>/<sub>4</sub>"L x 9<sup>5</sup>/<sub>8</sub>"H



Part No. 54  
Bassinet Pad - Grey

#### pad measures

12<sup>1</sup>/<sub>2</sub>"W x 26<sup>1</sup>/<sub>2</sub>"L x 1" Thick



## mayo stands

### foot-pedal operated

- Base designed to move under low clearance equipment with maximum stability
- Convenient foot-pedal operated lock adjusts height from 36" to 62"
- **co•re casters™** corrosion-resistant, maintenance-free
- All welded stainless steel construction



**P-1065-SS**

- Removable extra large 20" x 25" stainless steel tray for easy cleaning
- Two 2" corrosion-resistant Gemini **co•re casters™**
- 50 lbs. weight capacity evenly distributed



**P-1066-SS**

- Removable 16¼" x 21¼" stainless steel tray for easy cleaning
- Two 2" corrosion-resistant Gemini **co•re casters™**
- 50 lbs. weight capacity evenly distributed



**P-1068-SS**

- Removable 12<sup>5</sup>/<sub>8</sub>" x 19<sup>1</sup>/<sub>8</sub>" stainless steel tray for easy cleaning
- Two 2" corrosion-resistant Gemini **co•re casters™**
- 50 lbs. weight capacity evenly distributed



**P-1069-SS**

- Removable large 16¼" x 21¼" stainless steel tray for easy cleaning
- Four 2" corrosion-resistant Gemini **co•re casters™**
- 50 lbs. weight capacity evenly distributed



# mayo stands



**P-1066-A-SS**

- Removable 16¼" x 21¼" stainless steel tray for easy cleaning
- Adjust height 36" to 60" - friction lock
- Two 2" corrosion-resistant Gemini **co•re casters**™
- 50 lbs. weight capacity evenly distributed



**P-1068-A-SS**

- Removable 12<sup>5</sup>/<sub>8</sub>" x 19<sup>1</sup>/<sub>8</sub>" stainless steel tray for easy cleaning
- Adjust height 36" to 60" - friction lock
- Two 2" corrosion-resistant Gemini **co•re casters**™
- 50 lbs. weight capacity evenly distributed

**hand operated**

- Base designed to move under low clearance equipment with maximum stability
- **co•re casters**™ corrosion-resistant, maintenance-free
- All welded stainless steel construction



**P-1069-A-SS**

- Removable large 16¼" x 21¼" stainless steel tray for easy cleaning
- Adjust height 36" to 60" - friction lock
- Four 2" corrosion-resistant Gemini **co•re casters**™
- 50 lbs. weight capacity evenly distributed



**P-66**

- Removable 19<sup>1</sup>/<sub>8</sub>"L x 12<sup>5</sup>/<sub>8</sub>"W stainless steel tray on powder-coated frame
- Adjust height from 32" to 53" - friction lock
- Two 3" corrosion-resistant **co•re casters**™
- 20 lbs. weight capacity evenly distributed



**P-65 Medical Tray Unit**

- Removable 19<sup>1</sup>/<sub>8</sub>"L x 12<sup>5</sup>/<sub>8</sub>"W stainless steel tray on chrome plated base
- Swivel height adjust from 30" to 40"
- Four 3" corrosion-resistant **co•re casters**™
- 40 lbs. weight capacity evenly distributed



**new!**  
**co•re  
caster™**

## basin stands

### features

- Open frame design allows access from all sides
- **co•re casters™** corrosion-resistant, maintenance-free
- Elevated ring basin bracket
- Mobile and easy to clean



**P-78**

- Single basin stand
- Near chrome powder coat finish
- 13¾"D x 14"W x 33¾"H
- One removable 13½" diameter, 7 quart stainless steel basin
- Steel construction

**P-1078-SS**

- Single basin stand
- Stainless steel
- 13¾"D x 14"W x 33¾"H



**P-1078-W/S-SS**

- Single basin stand with shelf
- Stainless steel
- 13¾"D x 14"W x 33¾"H
- One removable 13½" diameter, 7 quart stainless steel basin
- Stainless steel construction

**P-1079-W/S-SS**

- Double basin stand with shelf
- Stainless steel
- 14"D x 28"W x 33¾"H



**P-79**

- Double basin stand
- Near chrome powder coat finish
- 13¾"D x 28"W x 33¾"H
- Two removable 13½" diameter, 7 quart stainless steel basins
- Steel construction

**P-1079-SS**

- Double basin stand
- Stainless steel
- 14"D x 28"W x 33¾"H





### **P-1020-SS**

kick bucket

- Stainless steel

Overall size

13<sup>3</sup>/<sub>4</sub>" diameter x 13<sup>1</sup>/<sub>4</sub>"H

- Removable 12 quart, stainless steel bucket

## **kick buckets**

### **features**

- Balanced, tip-resistant
- Perimeter bumper to protect walls
- Electro-polished, stainless steel frame
- 2" diameter double ball bearing swivel casters for easy mobility



### **P-1025-SS**

sponge receptacle

- Stainless steel

Overall size

16<sup>1</sup>/<sub>2</sub>" diameter x 7<sup>1</sup>/<sub>2</sub>"H

- Removable 8<sup>1</sup>/<sub>2</sub> quart, stainless steel basin

**new!**

**P-1130-L-SS**

**Dimensions**

17¾"D x 18"W x 31"H

- Stainless Steel
- Quiet-Close™ lid dampener
- 3" **co•re casters**™
- Foot operated
- Accommodates 18" bags



**P-1130-SS**

**Dimensions**

14"D x 16"W x 30¾"H

- Stainless Steel
- No lid
- 3" **co•re casters**™
- Accommodates 18" bags

**new!**  
**co•re  
caster™**

# hampers

Pedigo's newly designed lidded hampers feature the **Quiet-Close™** lid dampener for improved safety and added control of airborne bacteria and odors.

Linen hampers are constructed of heavy gauge steel and feature double ball bearing, 3" corrosion-resistant **co•re casters™** for easy mobility.



*Quiet-Close™ lid dampener*



P-120-L and P-121-L



P-1120-L-SS and P-1121-L-SS



P-120 and P-121



P-1120-SS and P-1121-SS

**P-120-L**

**Dimensions**

32"H with a 59½" perimeter

- Powder coated steel
- Foot operated
- Accommodates 18" bags

**P-1120-L-SS**

**Dimensions**

32"H with a 59½" perimeter

- Stainless steel
- Foot operated
- Includes rolling bumpers
- Accommodates 18" bags

**P-120**

**Dimensions**

32"H with a 59½" perimeter

- Powder coated steel
- Accommodates 18" bags

**P-1120-SS**

**Dimensions**

32"H with a 59½" perimeter

- Stainless steel
- Includes rolling bumpers
- Accommodates 18" bags

**P-121-L**

**Dimensions**

35"H with a 80⅞" perimeter

- Powder coated steel
- Foot operated
- Accommodates 25" bags

**P-1121-L-SS**

**Dimensions**

35"H with a 80⅞" perimeter

- Stainless steel
- Foot operated
- Includes rolling bumpers
- Accommodates 25" bags

**P-121**

**Dimensions**

35"H with a 80⅞" perimeter

- Powder coated steel
- Accommodates 25" bags

**P-1121-SS**

**Dimensions**

35"H with a 80⅞" perimeter

- Stainless steel
- Accommodates 25" bags

**P-1015-TC**

**Dimensions**

28"D x 14¾"W x 40¼"H

- Stainless Steel
- Holds up to six P-1015
- 3" Genesis diameter swivel casters
- Genesis casters are maintenance-free (#62-B)



P-1015

# footstools

**features**

- Strong, all welded steel
- Legs and handrail constructed of 1" O.D. 16-gauge tubular steel
- Corrugated, black rubber top surface
- Rubber floor tips

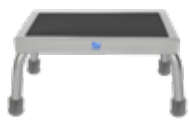

**P-10**

Powder Coat

12"D x 16"W x 8"H

300 lbs. weight capacity



**P-10-A**

Powder Coat

12"D x 16"W x 8"H

300 lbs. weight capacity

- 39"H with handrail



**P-1010-A-SS**

Stainless Steel

12"D x 16"W x 8"H

300 lbs. weight capacity

- 39"H with handrail



**P-1010-SS**

Stainless Steel

12"D x 16"W x 8"H

300 lbs. weight capacity



**P-18**

Powder Coat

12"D x 16"W x 16¼"H

300 lbs. weight capacity

- First step 9"H
- Second step 16¼"H



**P-18-A**

Powder Coat

12"D x 16"W x 16¼"H

300 lbs. weight capacity

- First step 9"H
- Second step 16¼"H
- 47"H with handrail



**P-11**

Powder Coat

12"D x 30"W x 8"H

300 lbs. weight capacity



**P-1011-SS**

Stainless Steel

12"D x 30"W x 5"H

300 lbs. weight capacity



**P-1012-SS**

Stainless Steel

12"D x 30"W x 8"H

300 lbs. weight capacity



**P-1015**

Stainless Steel

14"D x 19"W x 6¼"H

- 650 lbs. weight capacity
- Interlock footstools to create larger platforms
- Heavy gauge legs and handles

Safely stack for increased height



### P-1037-SS

- 14" round stainless steel contoured seat
- Rubber floor tips
- Height adjustment (screw shaft) of 20<sup>1</sup>/<sub>8</sub>" to 32<sup>3</sup>/<sub>8</sub>"

### P-1037-W/C-SS

- 3" **co-re casters**<sup>™</sup>
- Height adjustment (screw shaft) of 22<sup>1</sup>/<sub>2</sub>" to 34<sup>5</sup>/<sub>8</sub>"

## seating

stainless steel series

### features

- weight capacity rating of 300 lbs.
- Available in Classic

### upholstery

- classic ●
- royal ●

### dual wheel locking casters option

- 66 Locking Casters (activated upon standing)
- 01-B Adaptor (required for 66)



### ● P-1038-SS ● T-1038-SS

- 14" round cushioned seat
- Rubber floor tips
- Height adjustment (screw shaft) of 22" to 34<sup>1</sup>/<sub>2</sub>"

### ● P-1038-W/C ● T-1038-W/C

- 3" **co-re casters**<sup>™</sup>
- Height adjustment (screw shaft) of 24<sup>1</sup>/<sub>4</sub>" to 36<sup>3</sup>/<sub>4</sub>"



### ● P-1039-SS ● T-1039-SS

- 14" round cushioned seat
- Upholstered spring back
- Rubber floor tips
- Height adjustment (screw shaft) of 22<sup>3</sup>/<sub>4</sub>" to 34<sup>1</sup>/<sub>2</sub>"

### ● P-1039-W/C ● T-1039-W/C

- 3" **co-re casters**<sup>™</sup>
- Height adjustment (screw shaft) of 25" to 36<sup>3</sup>/<sub>4</sub>"



**new!**  
**co-re  
caster**<sup>™</sup>

### ● P-1040-SS ● T-1040-SS

- 14" x 15" cushioned square seat
- Upholstered spring back
- 3" **co-re casters**<sup>™</sup>
- Height adjustment (screw shaft) of 26" to 37<sup>1</sup>/<sub>2</sub>"



- **P-36** ● **T-36**
- 14" round cushioned seat
- 3" **co-re casters™**
- Height adjustment (screw shaft) of 17<sup>7</sup>/<sub>8</sub>" to 26<sup>1</sup>/<sub>4</sub>"



- **P-38** ● **T-38**
- 14" round cushioned seat
- Rubber floor tips
- Height adjustment (screw shaft) of 22" to 34<sup>1</sup>/<sub>2</sub>"

- **P-38-W/C** ● **T-38-W/C**
- 3" **co-re casters™**
- Height adjustment (screw shaft) of 24<sup>1</sup>/<sub>4</sub>" to 36<sup>3</sup>/<sub>4</sub>"



- **P-39** ● **T-39**
- 14" round cushioned seat
- Rubber floor tips
- Upholstered spring back
- Height adjustment (screw shaft) of 22<sup>3</sup>/<sub>4</sub>" to 34<sup>1</sup>/<sub>2</sub>"

- **P-39-W/C** ● **T-39-W/C**
- 3" **co-re casters™**
- Height adjustment (screw shaft) of 24<sup>1</sup>/<sub>4</sub>" to 36<sup>3</sup>/<sub>4</sub>"



- **P-51** ● **T-51**
- 14" x 15" square cushioned seat
- Upholstered spring back
- 3" **co-re casters™**
- Height adjustment (screw shaft) of 18<sup>5</sup>/<sub>8</sub>" to 26<sup>1</sup>/<sub>4</sub>"



- **P-51-R** ● **T-51-R**
- 14" round cushioned seat
- Upholstered spring back
- 3" **co-re casters™**
- Height adjustment (screw shaft) of 18<sup>5</sup>/<sub>8</sub>" to 26<sup>1</sup>/<sub>4</sub>"



- **P-55** ● **T-55**
- Lab stool
- 14" x 15" square cushioned seat
- Upholstered spring back
- Plastic floor glide
- Height adjustment (screw shaft) of 21<sup>5</sup>/<sub>8</sub>" to 33<sup>5</sup>/<sub>8</sub>"

## seating

### powder-coat series

#### features

- weight capacity rating of 300 lbs.

#### upholstery

- classic ●
- royal ●

#### dual wheel locking casters option

- 66 Locking Casters (activated upon standing)
- 01-B Adaptor (required for 66)





• **P-527-GS**      • **T-527-GS**

- 14½" round fully padded seat
- 23½" diameter aluminum base
- 2" dual wheel casters
- Adjustable backrest
- Height adjustment of 19¼" to 24½" (pneumatic)



• **P-528-GS**      • **T-528-GS**

- 14½" round fully padded seat
- 23½" diameter aluminum base
- 2" dual wheel casters
- Height adjustment of 19¼" to 24½" (pneumatic)

## seating

foot-operated

### features

- weight capacity rating of 300 lbs.

### upholstery

- classic ●
- royal ●

### locking casters option

- 66 Locking Casters (activated upon standing)
- 66-A Locking Casters (activated upon sitting)

# seating

## five series



• **P-521-GS**  
• **T-521-GS**

- 14½" round fully padded seat with back
- 23½" diameter aluminum base
- 2" dual wheel casters
- Height adjustment (pneumatic) of 19¼" to 23¾"
- Adjustable backrest



• **P-526-GS**  
• **T-526-GS**

- 14½" round fully padded seat
- 23½" diameter aluminum base
- 2" dual wheel casters
- Height adjustment (pneumatic) of 19¼" to 23¾"



• **P-536**  
• **T-536**

- 14" round cushioned seat
- 21½" diameter chrome base
- 3" **co-re casters™**
- Height adjustment (screw shaft) of 17¾" to 26⅛"

\* locking casters option not available

### features

- weight capacity rating of 300 lbs.

### upholstery

- classic ●
- royal ●

### dual wheel locking casters option

- 66 Locking Casters (activated upon standing)
- 66-A Locking Casters (activated upon sitting)



• **P-536-GS** • **T-536-GS**

- 14" cushioned seat
- 21½" diameter chrome base
- 3" **co-re casters™**
- Height adjustment (pneumatic) of 18¾" to 23½"



• **P-551** • **T-551**

- 16" x 17" cushioned seat
- 21½" diameter chrome base
- Adjustable back support
- 3" **co-re casters™**
- Height adjustment (screw shaft) 20⅝" to 29"
- Adjustable backrest

\* locking casters option not available



• **P-551-GS** • **T-551-GS**

- 16" x 17" cushioned seat
- 21½" diameter chrome base
- Adjustable back support
- 3" **co-re casters™**
- Height adjustment (pneumatic) of 19¼" to 24" height
- Adjustable backrest

\* locking casters option not available



• **P-555-GS** • **T-555-GS**

- 16" x 17" cushioned seat
- 21½" diameter chrome base
- Adjustable back support
- 3" **co-re casters™**
- Height adjustment (pneumatic) of 25⅝" to 33"
- Adjustable backrest

\* locking casters option not available



● **T-580**

- 18" x 19" contoured cushioned seat
- Height adjustment (pneumatic) of 17½" to 23¼"
- Easy rolling 2" dual wheel casters
- 25" diameter footprint
- Adjustable backrest
- Adjustable arm rests



● **T-581**

- 18" x 19" contoured cushioned seat
- Height adjustment (pneumatic) of 17½" to 23¼"
- Easy rolling 2" dual wheel casters
- 25" diameter footprint
- Adjustable backrest



● **T-582**

- 18" x 19" contoured cushioned seat
- Height adjustment (pneumatic) of 17½" to 23¼"
- Easy rolling 2" dual wheel casters
- 23" diameter footprint (small)
- Adjustable backrest

## seating

ergo task chair

**features**

Pedigo's ergonomically designed task chairs feature pneumatic height adjustment, dual wheel casters, 5-star base, integrated lumbar support, and independent backrest/seat pan height and tilt controls. PVC and latex free.

- weight capacity rating of 300 lbs.

**upholstery**

- only available in royal ●

**locking casters option**

- 81 Locking Casters (activated upon standing)



● **T-583**

- 18" x 19" contoured cushioned seat
- Height adjustment (pneumatic) of 24¼" to 34¼"
- Easy rolling 2" dual wheel casters
- 25" diameter footprint
- Adjustable backrest
- Adjustable arm rests

● **T-584**

- 18" x 19" contoured cushioned seat
- Height adjustment (pneumatic) of 23½" to 33½"
- Easy rolling 2" dual wheel casters
- 25" diameter footprint
- Adjustable backrest

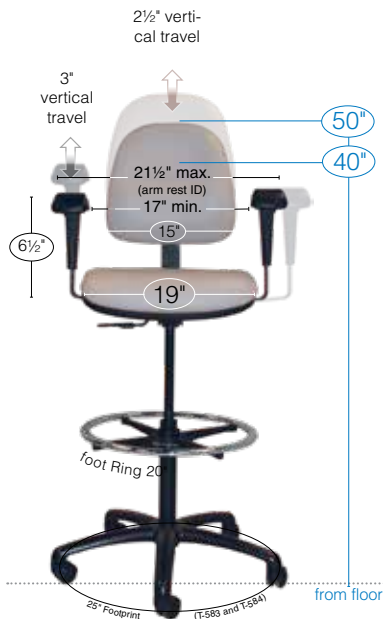

specs



# seating

## ergo task anesthesia chair

**features**

Ergonomically designed anesthesia chair, Pedigo's T-583 features pneumatic height adjustment, dual wheel casters, 5-star base, integrated lumbar support and independent backrest/seat pan height tilt controls. PVC and latex free.

- weight capacity rating of 300 lbs.

**upholstery**

- only available in royal ●

**locking casters option**

- 81 Locking Casters (activated upon standing)



Locking Casters

● **P-7000**

- Specially contoured seat for added comfort
- Sensafoam body contouring seat and back
- Seat features backrest
- Height adjustable and articulating arm/wrist rests
- 21" diameter base with high grade 3" casters
- 5-caster base
- Three locking casters
- Adjustable backrest
- Height adjustment (hydraulic) of 20<sup>3</sup>/<sub>4</sub>" to 28<sup>1</sup>/<sub>4</sub>" - single pedal, foot-operated

# seating

## hydraulic surgeon chair

### features

Hydraulic Surgeon Chairs are ideal for surgery, anesthesiology, ENT and reconstructive procedures.

- weight capacity rating of 300 lbs.

### upholstery

- only available in classic ●

### option (P-6000)

- articulating arm rests #P-6000-D



●● **P-6000** with Backrest

- 16" round fully padded
- Seat features backrest
- 21" diameter base
- Powder-coated 5-caster base
- High grade 3" casters
- Three locking casters
- Height adjustment (hydraulic) of 22<sup>3</sup>/<sub>4</sub>" to 30<sup>1</sup>/<sub>4</sub>" - single pedal, foot-operated



●● **P-6001** without Backrest

- 16" round fully padded
- No backrest
- 21" diameter base
- Powder-coated 5-caster base
- High grade 3" casters
- Three locking casters
- Height adjustment (hydraulic) of 22<sup>3</sup>/<sub>4</sub>" to 30<sup>1</sup>/<sub>4</sub>" - single pedal, foot-operated



●● **P-6001** with Procedure Rest

- Rotates a full 360 degrees
- Upholstered for comfort
- Special density foam provides comfort and support during long procedures
- 16" round fully padded
- Height adjustment of 24<sup>3</sup>/<sub>8</sub>" to 29<sup>1</sup>/<sub>2</sub>"

Part No. P-6000-PR and P-6001



●● **P-526** with Procedure Rest

- Rotates a full 360 degrees
- Upholstered for comfort
- Special density foam provides comfort and support during long procedures
- 14<sup>1</sup>/<sub>2</sub>" round fully padded seat
- Height adjustment of 21<sup>1</sup>/<sub>2</sub>" to 23<sup>3</sup>/<sub>4</sub>"

Part No. P-526-PR and P-526-GS

\* Seat tilt not available with procedure rest



# upholstery chart

**Classic** Durable, vinyl based fabrics, Pedigo Classic upholstery is latex-free and California TB-117 approved.  
**Indicates:** Pedigo Classic upholstery and unit testing:

- California TB-117



**Royal** Environment friendly, Pedigo Royal upholstery is latex-free, PVC-free, California TB-117 approved.  
**Indicates:** Pedigo Royal upholstery and unit testing:

- California TB-117
- California TB-117 and TB-133 approved



Above color samples are representations of upholstery materials. Actual colors may vary slightly. Material samples available upon request.

**Technical Bulletins** The State of California developed a number of testing standards known as Technical Bulletins for the purpose of evaluating the flammability of furniture.

- **CAL TB-117** Flammability test for the filling or padding material of furniture. Tests the flame retardance of resilient filling materials used in upholstered furniture - including the fabric.



- **CAL TB-133** A full-scale fire test of the entire unit including the frame, foam and upholstery.



- **American National Standard for Office Furnishings** This standard is intended to provide manufacturers, specifiers, and users with a common basis for evaluating the safety, durability, and structural adequacy of general-purpose office chairs. For example, load and impact testing.



- **Business & Institutional Furniture Manufacturer's Assoc.** A not-for-profit organization that advocates, informs and develops standards for the North American office and institutional furniture industry.



## Care Instructions

PreFixx® is engineered so that upholstery can be cleaned again and again without showing signs of wear. With easy cleanability, and proven stain and abrasion resistance, PreFixx protective finish can reduce maintenance costs and frequent re-upholstery.

**Performance:** Offers state-of-the-art resistance against staining, burnishing, abrasion, scuffing and blocking.

**Durability:** Creates a barrier that resists stains from penetrating to the surface of the vinyl for proven, long-lasting protection. With laboratory-tested stain resistance and improved wear properties, upholstery treated with PreFixx protective finish can retain a “like-new” appearance longer.

**Easy Maintenance:** Enables most common stains like dirt and smudges to wipe off easily. Many difficult stains like ballpoint ink also can be cleaned with active solvents, such as nail polish remover, without damaging the PreFixx protective finish (when recommended cleaning instructions are followed).



# space station

two tier back table

**CDS-3060** Dimensions  
 Main Table 30"D x 60"W x 34"H  
 Top Shelf 20"D x 60"W



**CDS-3072** Dimensions  
 Main Table 30"D x 72"W x 34"H  
 Top Shelf 20"D x 72"W

A specialty back table designed with additional room for large cases such as orthopedics, spinal fusions, neuro and craniotomies. The tuck-away cantilevered shelf holds multiple trays and is angled for clear observation of instruments.

The Space Station is easily rolled into position using 4" diameter, heavy-duty ball bearing brake/swivel casters. To lock swivel caster, simply engage the single-pedal brake.

## One Person Operation



Pneumatic assist enables one-person operation in raising or lowering the cantilevered shelf.



Shelf is easily raised when extra space is required, or lowered into storage position if not needed.

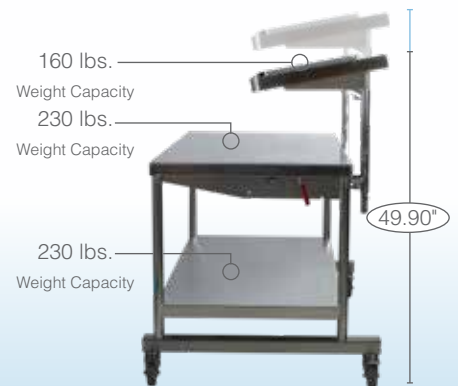

Cantilevered shelf features a 10° slope and has an adjustable height from 49.9" to 52.9".

**trusted fit** **drapes**  
 two-tier

## Disposable Table Drapes

Pedigo Trusted Fit drapes feature heavy-duty three layer construction. 12 Drapes per case.

**CDS-3060-DD** 5' table (1.5m)  
**CDS-3072-DD** 6' table (1.8m)





Elevate & Illuminate Table  
 CDS-3060-ADJ-E ....5' table (1.5m)  
 CDS-3072-ADJ-E ....6' table(1.8m)  
 Illuminate Table  
 CDS-3060-L.....5' table (1.5m)  
 CDS-3072-L.....6' table(1.8m)



# space station

electric adjustable back table

Pedigo's **NEW** Space Station back table is now electro-hydraulically height adjustable and LED illuminated for improved visibility.

efficiency • ergonomic • safety

For patient and staff safety, the Space Station Two-Tier Back Table meets the highest hospital safety standards. IEC 60601-1 and UL approved E 503 186 approved.



Power Supply

Height Adjustment

The UP/DOWN buttons for height control are located to the left of the power supply.

Cord Loops

Power Cord

Hospital grade power cord can be wound around cord loops when not in use. Cord length measures 9' 8" (3m).

Latch Release

Pull up on the release latch to disengage and lower upper tier. Release Latches are located on either side of the table.



**Casters**

The Electric Adjustable Space Station features four Total Lock Casters each measuring 4" (10cm) in diameter.



**Power Supply**

At the back of the table are two independent ON/OFF toggle switches to control the entire table unit and a second for the LED lights.



draping  
**Space Station**  
 video demo

draping video demo online  
[www.pedigo-usa.com](http://www.pedigo-usa.com)

**new!**



# space station

electric adjustable back table

Pedigo's **NEW** Space Station back table is now electro-hydraulically height adjustable and LED illuminated for improved visibility.

efficiency • ergonomic • safety

For patient and staff safety, the Space Station Two-Tier Back Table meets the highest hospital safety standards. IEC 60601-1 and UL approved E 503 186 approved.



Elevate & Illuminate Table  
 CDS-3060-ADJ-E ... 5' table (1.5m)  
 CDS-3072-ADJ-E ... 6' table(1.8m)



Illuminate Table  
 CDS-3060-L ..... 5' table (1.5m)  
 CDS-3072-L ..... 6' table(1.8m)



Upper tier in storage position

Upper tier being raised

Upper tier in raised position

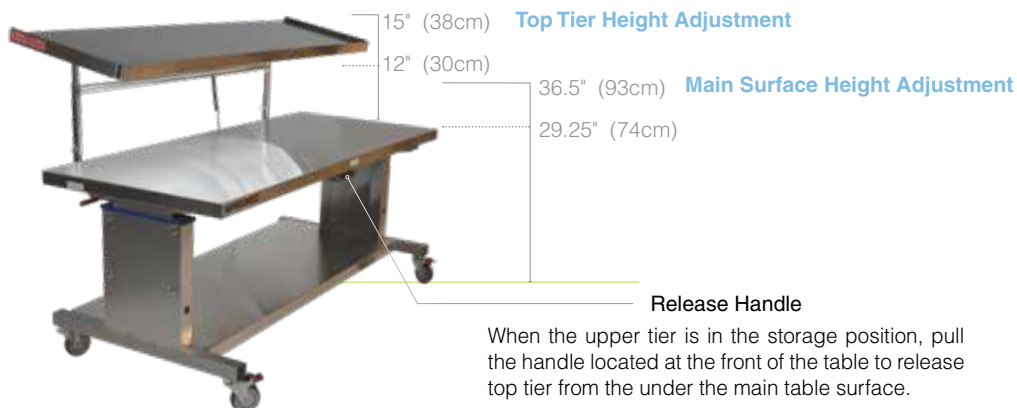

When the upper tier is in the storage position, pull the handle located at the front of the table to release top tier from the under the main table surface.



### CDS-1100

Main Table Top Surface  
72"W x 30"D

Height Adjustable  
32" to 43¼"H

## instrument assembly station table

### features

- Electrically operated hydraulic height adjustment provides comfortable, ergonomic height settings for all staff members.
- Shelves are positioned 18" and 30" above main work surface, and measure 72"W x 12"D with 5/8" front lip.
- Shelves also feature a 10° slope.
- Load capacity of 225 pounds on main work surface and 50 pounds on each upper shelf.
- 4" zinc plated steel brake/swivel lock casters with precision ball bearings for easy mobility.

### accessories

#### ① Work Lamp **CDS-1020**

- Work Lamp arm has a 42" reach
- Features a 5" viewing lens
- 75% magnification

#### ② Outlet Strip **CDS-1015**

- Hospital grade
- Six outlets
- 15' foot cord

#### ③ Keyboard Tray **CDS-1032**

- Measures 22¼"W x 10"D x 2¾"H
- Tray extends 10½" (retractable)
- Built-in mouse tray comes standard

#### ④ Computer Enclosure **CDS-1031**

- Open back for air flow and easy access to computer cords.
- Enclosure can be customized to accommodate larger computer towers (max. load 30 lbs/13.60 kg)

#### ⑤ Extension Arm **CDS-1030**

- Supports LCD monitors (max. load 25 lbs / 11.3 kg)
- For optimal viewing, extension arm features multi-directional adjustment
- Gas-strut and ball-joint system for smooth, stable operation

#### ⑥ Storage Cart **CDS-1010**

- 4 drawer tote box cart for added storage fits under the workstation
- Totes are constructed of impact-resistant, high-density polyethylene and measure 17¾"L x 14½"W x 5"D





SG-82-SS

**new!**  
**co•re  
caster™**

### Mid-Size Tables with Shelf

#### Dimensions

SG-82-SS	20"W x 16"D x 34"H
SG-84-SS	30"W x 16"D x 34"H
SG-86-SS	33"W x 18"D x 34"H
SG-88-SS	36"W x 20"D x 34"H

### features

- Stainless steel Steril-Gard construction eliminates full sub-tops where undesirable substances can collect
- Easy to clean
- Lightweight but strong
- 3" double ball bearing, corrosion-resistant **co•re casters™**
- Sound-deadened reinforcing channels for quiet use\*

\* feature not present on model SG-82-SS



SG-87-SS

### Mid-Size Tables without Shelf

#### Dimensions

SG-83-SS	20"W x 16"D x 34"H
SG-85-SS	30"W x 16"D x 34"H
SG-87-SS	33"W x 18"D x 34"H
SG-89-SS	36"W x 20"D x 34"H



SG-92-SS

### Large Tables with Shelf

#### Dimensions

SG-90-SS	48"W x 20"D x 34"H
SG-92-SS	48"W x 24"D x 34"H
SG-94-SS	60"W x 24"D x 34"H
SG-96-SS	72"W x 24"D x 34"H
SG-98-SS	36"W x 24"D x 34"H



SG-93-SS

### Large Tables without Shelf

#### Dimensions

SG-91-SS	48"W x 20"D x 34"H
SG-93-SS	48"W x 24"D x 34"H
SG-95-SS	60"W x 24"D x 34"H
SG-97-SS	72"W x 24"D x 34"H
SG-99-SS	36"W x 24"D x 34"H

### options

- 3 or 4 sided top and shelf rails available for all tables.
- Stainless steel drawers, or tote boxes may be mounted under top.
- Table height can be modified

#### Tote Boxes

Impact-resistant, high-density polyethylene.

- CDS-TB-5" (17¾"L x 14½"W x 5¹⁄₈"D)
- CDS-TB-10" (17¾"L x 14½"W x 10"D)

#### Tote Box Hangers

- SG-TBH-1 16"D SG Tables
- SG-TBH-2 18"D SG Tables
- SG-TBH-3 20"D SG Tables
- SG-TBH-4 24"D SG Tables

#### Glides/ Rubber Feet/ Casters

- #15 Glides
- #13 Rubber Feet
- #06 Locking Casters

#### IV Pole for SG Tables

- P-7202-1 available on lower shelf models only.



**SG-80-SS**

table with shelf, drawer and rail

overall size  
20"W x 16"D x 34"H

drawer size  
15¼"W x 12½"L x 3"H (I.D.)



**utility**  
tables

**features**

- Convenient and easy to use
- Stainless steel, Steril-Gard construction eliminates full sub-tops
- Improves the control of undesirable substances
- Full extending drawer hangers (except SG-81-SS)
- Sound-proofed reinforcing channels for quiet use and added strength
- 3" double ball bearing, rubber casters for silent mobility
- 1½" high 3-sided top rail

**options**

- Part No. 46-B Drawer lock with key
- Part No. 06 3" casters with brakes



**SG-80-A-SS**

table with shelf, two drawers and rail

overall size  
20"W x 16"D x 34"H

drawer size (I.D.)  
15¼"W x 12½"L x 3"H



**SG-80-B-SS**

table with shelf and drawer

overall size  
20"W x 16"D x 34"H

drawer size (I.D.)  
15¼"W x 12½"D x 3"H



**SG-80-C-SS**

table with shelf and two drawers

overall size  
20"W x 16"D x 34"H

drawer size (I.D.)  
15¼"W x 12½"D x 3"H



**SG-81-SS**

table with shelf and rail

overall size  
20"W x 16"D x 34"H



**SG-82-SS**

table with shelf

overall size  
20"W x 16"D x 34"H



shown with optional accessories

### CDS-2472

overall size: 72"W x 24"D x 34"H

#### optional accessories

- 4" swivel casters with brakes
- Full length lower shelf
- Tote box drawers:  
5" or 10" deep
- Stainless steel drawers:  
15½"W x 12½"D x 3½"H (installed, complete)



Caster with brake

## central supply tables

#### features

- Heavy duty, all stainless steel construction
- Height adjustable floor glides
- For use in areas where a table larger than a standard utility or work table is needed



shown with optional accessories

### CDS-3260

Overall size: 60"W x 32"D x 34"H

#### optional accessories

- 4" swivel casters with brakes
- Full length lower shelf
- Sterile Wrap frame:  
56"W x 30½"H
- Tote box drawers:  
5" or 10" deep
- Stainless steel drawers:  
15½"W x 12½"D x 3½"H (installed, complete)



Caster with brake



shown with optional accessories

### CDS-3684

Overall size: 84"W x 36"D x 34"H

#### optional accessories

- 4" swivel casters with brakes
- Full length lower shelf
- Tote box drawers:  
5" or 10" deep
- Stainless steel drawers:  
15½"W x 12½"D x 3½"H (installed, complete)



Caster with brake



**P-5182** Dimensions



Standard Top 34"W x 42"D

Pedigo's Over-Operating Specialty Table is constructed of stainless steel and features easy, one-hand height adjustment.

- 3" total lock casters, with brakes and swivel locks
- Adjustable height from 37¼" to 52¼" high from floor
- 27¾" clearance between legs
- Other sizes available upon request.



**P-5190-E** Dimensions

Standard Top 36"W x 42"D

**Adjustable Over-Operating Table** may be height adjusted during the surgical case while the staff is gowned and sterile. To raise or lower the main table surface, simply engage the electric motor by depressing the foot pedal.

- 3" total lock casters, with brakes and swivel locks
- 28⅞" clearance between legs
- Adjustable height from 40½" to 51½" high from floor (underside of table height from 35½" to 46½" high from floor)

# over-operating tables

Part Number	Description	Dimension			
P-5182-3	Base ONLY (Standard)	28" ID Clearance			
P-5182-34	Base ONLY (Wide)	34" ID Clearance			
P-5182-36	Base ONLY (X-Wide)	36" ID Clearance			
			Base (P-5182-3)	Base (P-5182-34)	Base (P-5182-36)
P-5182-2	Top ONLY (Standard)	34"W x 42"D	•		
P-5182-3420	Top ONLY	34"W x 20"D	•		
P-5182-3424	Top ONLY	34"W x 24"D	•		
P-5182-3430	Top ONLY	34"W x 30"D	•		
P-5182-3436	Top ONLY	34"W x 36"D	•		
P-5182-3448	Top ONLY	34"W x 48"D	•		
P-5182-3820	Top ONLY	38"W x 20"D	•		
P-5182-3824	Top ONLY	38"W x 24"D	•		
P-5182-3830	Top ONLY	38"W x 30"D	•		
P-5182-3836	Top ONLY	38"W x 36"D	•		
P-5182-3842	Top ONLY	38"W x 42"D	•		
P-5182-3848	Top ONLY	38"W x 48"D	•		
P-5182-4220	Top ONLY	42"W x 20"D	•	•	•
P-5182-4224	Top ONLY	42"W x 24"D	•	•	•
P-5182-4230	Top ONLY	42"W x 30"D	•	•	•
P-5182-4236	Top ONLY	42"W x 36"D	•	•	•
P-5182-4242	Top ONLY	42"W x 42"D	•	•	•
P-5182-4248	Top ONLY	42"W x 48"D	•	•	•
P-5182-4620	Top ONLY	46"W x 20"D	•	•	•
P-5182-4624	Top ONLY	46"W x 24"D	•	•	•
P-5182-4630	Top ONLY	46"W x 30"D	•	•	•
P-5182-4636	Top ONLY	46"W x 36"D	•	•	•
P-5182-4642	Top ONLY	46"W x 42"D	•	•	•
P-5182-4648	Top ONLY	46"W x 48"D	•	•	•

The various sizes/configuration shown in the chart above are **ONLY available for the P-5182 over-operating table.**

tri mode  
new!



**P-2420**

**OVERALL SIZE**

30"W x 21¼"D x 25¼"H

**COMPARTMENT SIZE**

- 4.75 cubic ft.
- 26½"W x 17"D x 18¼"H

• **tri mode Range:**

- Irrigation: 90°F - 150°F
- Injection: 90°F - 104°F
- Blanket: 90°F - 160°F

• **Total Capacity:**

- 20 1-liter bags or
- 24 1-liter bottles
- 9 - 12 blankets

• Data Logger (Option)

• Caster (Option)

tri mode  
new!



**P-2430**

**OVERALL SIZE**

30"W x 27½"D x 25¼"H

**COMPARTMENT SIZE**

- 5.5 cubic ft.
- 26½"W x 19¾"D x 18¼"H

• **tri mode Range:**

- Irrigation: 90°F - 150°F
- Injection: 90°F - 104°F
- Blanket: 90°F - 160°F

• **Total Capacity:**

- 30 1-liter bags or
- 48 1-liter bottles
- 10 - 14 blankets

• Data Logger (Option)

• Caster (Option)

# warming cabinets

blanket & fluid

**features**

Combination warmers feature tri-temp chamber allowing for 3 different modes of warming, LED display, window doors, and control lock programming.

**WarmSafe™**  
technology



**P-2010-S**

**OVERALL SIZE**

16½"W x 25¼"D x 21½"H

**COMPARTMENT SIZE**

- 2.3 cubic ft.
- 13¼"W x 21¾"D x 14"H

• **Temp Range:**

- Blankets: 98°F - 200°F

• **Total Capacity:**

- 5 - 7 blankets

• Solid door

• Caster (Option)



**P-2012**

**OVERALL SIZE**

18½"W x 22"D x 22"H

**COMPARTMENT SIZE**

- 2.5 cubic ft.
- 15½"W x 18½"D x 15"H

• **Temp Range:**

- Blanket: 90°F - 160°F

• **Total Capacity:**

- 4 - 6 blankets

• Caster (Option)

Heated center shelf



**P-2022**

**OVERALL SIZE**

18½"W x 22"D x 28"H  
18½"W x 23"D x 34½"H (with casters)

**COMPARTMENT SIZE**

- 3.5 cubic ft.
- 15½"W x 18½"D x 21"H\*

\* (9 7/16" H above and below the center shelf)

• **Temp Range:**

- Blanket: 90°F - 160°F

• **Total Capacity:**

- 10 - 12 blankets

• Caster (Option)

shown with left door  
hidge mount option



**P-2032**

**OVERALL SIZE**

24"W x 24½"D x 35½"H  
24"W x 25¼"D x 42"H (with casters)

**COMPARTMENT SIZE**

- 7.5 cubic ft.
- 21"W x 21"D x 28"H

\* (13 3/16" H above and below the center shelf)

• **Temp Range:**

- Blanket: 90°F - 160°F

• **Total Capacity:**

- 20 - 25 blankets

• Caster (Option)





shown with bumper option

## P-2040

### OVERALL SIZE *(without bumper)*

22"W x 34½"D x 72½"H

### COMPARTMENT SIZE

- 7.7 cubic ft. upper
- 19"W x 26½"D x 26¾"H
- 7.7 cubic ft. lower
- 19"W x 26¼"D x 26¾"H

- **Temp Range:**
  - Blankets: 98°F - 160°F
  - Irrigation: 90°F - 150°F
- **Total Capacity:**
  - 40-50 blankets or,
  - 72 1-liter bags or,
  - 54 1-liter bottles
- Two compartments, each with individual controls
- 5" casters
- Bumper (Option)

# warming cabinets

## blanket & fluid

### features

Combination fluid and blanket warmers feature LED display, window doors, and control lock programming.

- No fans or lint traps
- Two compartments, each with individual controls

tri mode  
new!



## P-2147

### OVERALL SIZE

- 30"W x 28½"D x 75"H (caster standard)
- 30"W x 28½"D x 68"H (feet - option)

### COMPARTMENT SIZE

- 5.5 cu. ft. fluid compartment
- 26½"W x 23¾"D x 15"H
- 13.25 cu. ft. blanket compartment
- 26½"W x 23¾"D x 36"H

- **tri mode Range:**
  - Blankets: 90°F - 160°F
  - Irrigation: 90°F - 150°F
  - Injection: 90°F - 104°F
- **Total Capacity:**
  - 24-36 1-liter bags or,
  - 30 1-liter bottles
  - 10-14 blankets (upper chamber)
  - 30-40 blankets (lower chamber)
- Separate temperature controls for each compartment (**tri mode** top chamber only)
- 5" casters

tri mode  
new!



## P-2150

### OVERALL SIZE

- 30"W x 19¾"D x 75"H

### COMPARTMENT SIZE

- 3.7 cu. ft. fluid compartment
- 24¼"W x 18"D x 15"H
- 9 cu. ft. blanket compartment
- 24¼"W x 18"D x 36"H

- **tri mode Range:**
  - Blankets: 90°F - 160°F
  - Irrigation: 90°F - 150°F
  - Injection: 90°F - 104°F
- **Total Capacity:**
  - 24 1-liter bags or,
  - 20 1-liter bottles
  - 9-12 blankets (upper chamber)
  - 24-30 blankets (lower chamber)
- Separate temperature controls for each compartment (**tri mode** top chamber only)
- Pass Through (Option)
- Data Logger (Option)



### P-2055

#### OVERALL SIZE

35"W x 29¼"D x 71"H

#### COMPARTMENT SIZE

- 10.3 cubic ft. upper
- 26½"W x 23¾"D x 28⅜"H
- 10.3 cubic ft. lower
- 26½"W x 23¾"D x 28⅜"H

- Temp Range:
  - Blankets: 98°F - 160°F
- Total Capacity: 60-70 blankets
- One compartment, two separate doors
- Circulation fan for even temperature
- 5" casters

## warming cabinets

### blanket

#### features

Elite Series blanket warmers feature windowed door, programmable control with temperature lock and four digit LED display and single pane energy efficient coated glass window door allows inventory observation.

**WarmSafe™**  
technology



### P-2210

#### OVERALL SIZE

- 18½"W x 22"D x 22"H

#### COMPARTMENT SIZE

- 2.5 cubic ft.
- 15½"W x 18¾"D x 15¼"H

- Temp Range:
  - Blankets: 90°F - 160°F
- A warming shut-off system, separate from the electronic control, prevents overheating
- Interior blue lighting

Heated center shelf



### P-2220

#### OVERALL SIZE

- 18½"W x 22"D x 28"H

#### COMPARTMENT SIZE

- 3.5 cubic ft.
  - 15½"W x 18¾"D x 21¼"H\*
- \* (9 9/16"H above & below the center shelf)

- Temp Range:
  - Blankets: 90°F - 160°F
- A warming shut-off system, separate from the electronic control, prevents overheating
- Interior blue lighting



### P-2230

#### OVERALL SIZE

- 24"W x 24½"D x 22"H

#### COMPARTMENT SIZE

- 4 cubic ft.
- 21"W x 21½"D x 15¼"H

- Temp Range:
  - Blankets: 90°F - 160°F
- A warming shut-off system, separate from the electronic control, prevents overheating
- Interior blue lighting

Heated center shelf



### P-2240

#### OVERALL SIZE

- 24"W x 24¼"D x 35"H

#### COMPARTMENT SIZE

- 7.5 cubic ft.
  - 21"W x 21¾"D x 28¼"H\*
- \* (13 1/8"H above & below the center shelf)

- Temp Range:
  - Blankets: 90°F - 160°F
- A warming shut-off system, separate from the electronic control, prevents overheating
- Interior blue lighting



### P-2112

#### OVERALL SIZE

18½"W x 23½"D x 22"H

#### COMPARTMENT SIZE

- 2.5 cubic ft.
- 15½"W x 18¾"D x 15¼"H

- Temp Range:
  - Irrigation: 90°F - 150°F
  - Injection: 90°F - 104°F
- Total Capacity:
  - 16 1-liter bags or
  - 12 1-liter bottles
- Glide out basket
- Casters (option)



### P-2122

#### OVERALL SIZE

18½"W x 23½"D x 28"H

#### COMPARTMENT SIZE

- 3.5 cubic ft.
- 15½"W x 18¾"D x 21¼"H

- Temp Range:
  - Irrigation: 90°F - 150°F
  - Injection: 90°F - 104°F
- Total Capacity:
  - 24 1-liter bags or
  - 24 1-liter bottles
- Glide out basket
- Casters (option)

## warming cabinets

fluid

#### features

Fluid warmers feature 4 digit LED display, window doors, programmable temperature control and interior lighting.



### P-2030-TC

#### OVERALL SIZE

26"W x 33"D x 28"H

#### features

- Stainless steel
- 4" stainless steel casters with brakes
- 400 lbs. total weight capacity at 200 lbs. per shelf
- Top shelf
- Bottom shelf with 4-sided rail.
- Compatible with the P-2032, P-2230 and P-2240 warming cabinets

shown with the P-2010-S warmer



### P-2010-TC

#### OVERALL SIZE

23¼"W x 32¼"D x 43"H

#### features

- Stainless steel
- 4" casters with brake & swivel lock
- 300 lbs. total weight capacity at 100 lbs. per shelf
- Shelf Dimensions 17"W x 27"D x 12¼"H
- Compatible with the P-2010-S warming cabinet



### P-2010-CB

#### OVERALL SIZE

21¼"W x 29¾"D x 6<sup>13</sup>/<sub>16</sub>"H

#### features

- Platform
- 4" stainless steel casters with brakes
- 350 lbs. total weight capacity
- Perimeter bumper
- Cutouts in platform capture warming cabinet feet.
- Compatible with the P-2010-S warming cabinet

# warming cabinet features



## Fluid Warmers

- **WarmSafe™ Technology**
- Safety coated interior
- Fully insulated
- 120 VAC
- Heavy duty hardware
- Glass door
- Perimeter bumper (P-2130 only)

### Safety Features

- Built-in speaker for audible feedback
- Safety override feature prevents overheating
- Lockout feature

### Options

- Optional left hand door swing available
- Option of casters or fixed legs

### Warranty

- One Year Service
- Three Years on Parts
- Lifetime Technical Support



### Models

- P-2112
  - P-2122
  - P-2130
  - P-2140\*
- \* combination fluid/blanket warmer



## Blanket Warmers

- **WarmSafe™ Technology**
- Safety coated interior
- Fully insulated
- 120 VAC
- Heavy duty hardware
- Glass door (P-2010-S solid door)

### Safety Features

- Built-in speaker for audible feedback
- Safety override feature prevents overheating
- Lockout feature

### Options

- Optional left hand door swing available
- Option of casters or fixed legs
- Perimeter bumper is optional (excludes P-2055)

### Warranty

- One Year Service
- Three Years on Parts
- Lifetime Technical Support



### Models

- P-2010-S
- P-2012
- P-2022
- P-2032
- P-2040
- P-2055
- P-2210
- P-2220
- P-2230
- P-2240

## tri▼mode

## Blanket & Fluid Warmers

- **WarmSafe™ Technology**
- **tri▼mode**
- Safety coated interior
- Fully insulated
- 120 VAC
- Heavy duty hardware
- Glass or solid door

### Safety Features

- Built-in speaker for audible feedback
- Safety override feature prevents overheating (Deluxe models only)
- Lockout feature (Deluxe models only)

### Options

- Optional left hand door swing available
- Option of casters or fixed legs (excludes P-2150)
- Optional pass through warmer (P-2150 only).

### Warranty

- One Year Service
- Three Years on Parts
- Lifetime Technical Support



### Models

- P-2147
- P-2150
- P-2420
- P-2430



# ivNow

## individual warming pods

### Modular Configuration

Wall mount:

One to six (1-3) bag capacity

Countertop:

One to three (1-3) bag capacity

Pole mount:

One to three (1-3) bag capacity

### Temperature:

- Heats to 104°F (40°C) in 30 minutes or less (slightly longer heating time is required for 3L bags)
- Accuracy of +0°/-2°C (+0°/-3°F)

### Electronic Control

Monitors the length of time the bag has been held at temperature, displayed additionally by a status button. The control alerts users when a fluid bag has been held at temperature longer than 14 days.

### Warranty

1 year parts and labor



### features

The ivNow® fluid warmer quickly warms and maintains the temperature of injection/intravenous and irrigation solutions prior to their use. The specially contoured warming module cradles solution bags in 0.5-, 1-, 2- & 3-liter sizes. ivNow® units can be customized in the field by stacking or removing pods from the configuration. Units can be used for countertop use or wall mounted with the provided mounting plate.



### ivNow-1

The ivNow-1 may be placed directly on the countertop or fitted with an optional bracket for mounting on a stand or wall.

P-2301-A

#### Mount

- Equipment pole stand
- Wall mounting brackets

Capacity

One (1) bag, up to 3l \*



### ivNow-2

The ivNow-2 may be placed directly on the countertop or fitted with an bracket for mounting on a stand or wall.

P-2302-A

#### Mount

- Equipment pole stand
- Wall mounting brackets

Capacity

Two (2) bags, up to 3l \*



### ivNow-3

The ivNow-3 may be placed directly on the countertop or fitted with an bracket for mounting on a stand or wall.

P-2303-A

#### Mount

- Equipment pole stand
- Wall mounting brackets

Capacity

Three (3) bags, up to 3l \*





P-8230 Free-standing cabinet



Built-in cabinets with trim bezel



Sloped top with caster base

## operating room cabinets

### features

- Stainless steel cabinetry to maximize storage and space utilization
- Available as free-standing, built-in, or caster base models
- Adaptable to custom installations
- Radius glass panels for ease of cleaning
- Adjustable stainless steel door hinges
- Keyed door latch
- Adjustable nylon floor glides for leveling
- $\frac{3}{16}$ " tempered glass doors with stainless steel lockable paddle latch
- Double panel doors with FDA approved polyethylene foam for glass shock resistance
- Stainless steel shelves adjustable in  $\frac{1}{2}$ " increments

### options

- Stainless steel
- Built-in designs
- Trim bezel for built-in applications
- Caster base with locking casters (Cabinet model height will vary - consult drawing)
- Solid doors
- Additional shelves

Part No.	Dimensions	Shelves	Top
P-8010	25 <sup>3</sup> / <sub>4</sub> "W x 18"D x 60"H	3	Flat
P-8015	25 <sup>3</sup> / <sub>4</sub> "W x 18"D x 72"H	3	Sloped
P-8020	25 <sup>3</sup> / <sub>4</sub> "W x 24"D x 60"H	3	Flat
P-8025	25 <sup>3</sup> / <sub>4</sub> "W x 24"D x 75 <sup>5</sup> / <sub>8</sub> "H	3	Sloped
P-8030	47"W x 18"D x 60"H	3	Flat
P-8035	47"W x 18"D x 72"H	3	Sloped
P-8040	47"W x 24"D x 60"H	3	Flat
P-8045	47"W x 24"D x 75 <sup>5</sup> / <sub>8</sub> "H	3	Sloped
P-8070	35 <sup>3</sup> / <sub>8</sub> "W x 18"D x 60"H	3	Flat
P-8075	35 <sup>3</sup> / <sub>8</sub> "W x 18"D x 72"H	3	Sloped
P-8080	35 <sup>3</sup> / <sub>8</sub> "W x 24"D x 60"H	3	Flat
P-8085	35 <sup>3</sup> / <sub>8</sub> "W x 24"D x 75 <sup>5</sup> / <sub>8</sub> "H	3	Sloped
P-8110	25 <sup>3</sup> / <sub>4</sub> "W x 18"D x 72"H	4	Flat
P-8115	25 <sup>3</sup> / <sub>4</sub> "W x 18"D x 84"H	4	Sloped
P-8120	25 <sup>3</sup> / <sub>4</sub> "W x 24"D x 72"H	4	Flat
P-8125	25 <sup>3</sup> / <sub>4</sub> "W x 24"D x 87 <sup>5</sup> / <sub>8</sub> "H	4	Sloped
P-8130	47"W x 18"D x 72"H	4	Flat
P-8135	47"W x 18"D x 84"H	4	Sloped

Part No.	Dimensions	Shelves	Top
P-8140	47"W x 24"D x 72"H	4	Flat
P-8145	47"W x 24"D x 87 <sup>5</sup> / <sub>8</sub> "H	4	Sloped
P-8170	35 <sup>3</sup> / <sub>8</sub> "W x 18"D x 72"H	4	Flat
P-8175	35 <sup>3</sup> / <sub>8</sub> "W x 18"D x 84"H	4	Sloped
P-8180	35 <sup>3</sup> / <sub>8</sub> "W x 24"D x 72"H	4	Flat
P-8185	35 <sup>3</sup> / <sub>8</sub> "W x 24"D x 87 <sup>5</sup> / <sub>8</sub> "H	4	Sloped
P-8210	25 <sup>3</sup> / <sub>4</sub> "W x 18"D x 84"H	5	Flat
P-8215	25 <sup>3</sup> / <sub>4</sub> "W x 18"D x 96"H	5	Sloped
P-8220	25 <sup>3</sup> / <sub>4</sub> "W x 24"D x 84"H	5	Flat
P-8225	25 <sup>3</sup> / <sub>4</sub> "W x 24"D x 99 <sup>5</sup> / <sub>8</sub> "H	5	Sloped
P-8230	47"W x 18"D x 84"H	5	Flat
P-8235	47"W x 18"D x 96"H	5	Sloped
P-8240	47"W x 24"D x 84"H	5	Flat
P-8245	47"W x 24"D x 99 <sup>5</sup> / <sub>8</sub> "H	5	Sloped
P-8270	35 <sup>3</sup> / <sub>8</sub> "W x 18"D x 84"H	5	Flat
P-8275	35 <sup>3</sup> / <sub>8</sub> "W x 18"D x 96"H	5	Sloped
P-8280	35 <sup>3</sup> / <sub>8</sub> "W x 24"D x 84"H	5	Flat
P-8285	35 <sup>3</sup> / <sub>8</sub> "W x 24"D x 99 <sup>5</sup> / <sub>8</sub> "H	5	Sloped

## dimensions

or cabinets



Wall cabinet P-8535 with sloped top

### wall cabinets with glass doors

Part No.	Dimensions	Shelves	Doors	Top
P-8510	25¾"W x 13"D x 30"H	2	1	Flat
P-8515	25¾"W x 13"D x 39"H	2	1	Sloped
P-8530	47"W x 13"D x 30"H	2	2	Flat
P-8535	47"W x 13"D x 39"H	2	2	Sloped
P-8610	25¾"W x 13"D x 36"H	2	1	Flat
P-8615	25¾"W x 13"D x 45"H	2	1	Sloped
P-8630	47"W x 13"D x 36"H	2	2	Flat
P-8635	47"W x 13"D x 45"H	2	2	Sloped
P-8710	25¾"W x 13"D x 48"H	3	1	Flat
P-8715	25¾"W x 13"D x 57"H	3	1	Sloped
P-8730	47"W x 13"D x 48"H	3	2	Flat
P-8735	47"W x 13"D x 57"H	3	2	Sloped

### wall cabinets with solid doors

Part No.	Dimensions	Shelves	Doors	Top
P-8511	25¾"W x 13"D x 30"H	2	1	Flat
P-8516	25¾"W x 13"D x 39"H	2	1	Sloped
P-8531	47"W x 13"D x 30"H	2	2	Flat
P-8536	47"W x 13"D x 39"H	2	2	Sloped
P-8611	25¾"W x 13"D x 36"H	2	1	Flat
P-8616	25¾"W x 13"D x 45"H	2	1	Sloped
P-8631	47"W x 13"D x 36"H	2	2	Flat
P-8636	47"W x 13"D x 45"H	2	2	Sloped
P-8711	25¾"W x 13"D x 48"H	3	1	Flat
P-8716	25¾"W x 13"D x 57"H	3	1	Sloped
P-8731	47"W x 13"D x 48"H	2	2	Flat
P-8736	47"W x 13"D x 57"H	2	2	Sloped

## wall cabinets

### features

- Stainless steel cabinetry to maximize storage and space utilization
- Double panel doors with FDA approved polyethylene foam for glass shock resistance
- ¾" tempered glass doors with stainless steel lockable paddle latch
- Radius glass panels for ease of cleaning
- Adjustable stainless steel door hinges
- Stainless steel shelves adjustable in ½" increments

### options

- Keyed door latch
- Stainless steel pegboard
- Additional shelves
- Solid doors



Easily add additional storage space with Pedigo wall shelves.

## wall shelves

### features

- Stainless steel construction
- Pre-drilled for convenient wall mounting
- Shelves are available in a variety of sizes



**P-624-SS**  
6"D x 24"W



**P-630-SS**  
6"D x 30"W



**P-636-SS**  
6"D x 36"W



**P-824-SS**  
8"D x 24"W



**P-830-SS**  
8"D x 30"W



**P-836-SS**  
8"D x 36"W



### P-7202

Cardiac & Anesthesia Cabinet

#### Overall Size

28"W x 18"D x 33"H

#### Top Drawer

21¼"W x 16"D x 3¼"H

#### Bottom Drawer

21¼"W x 16"D x 3¼"H



shown with optional cart accessories

### P-7202-C

Same as P-7202 w/ complete accessory package

#### optional accessories for P-7202

- O<sub>2</sub> holder (holds 2 E-size tanks)
- 25' electrical outlet cord
- I.V. rod
- Push handle
- Cabinet locking rod

## anesthesia & treatment cabinets

#### P-7202 features

- Designed for cardiac and other emergency uses or as a large anesthesia cabinet
- Provides space for instruments, vials, and other necessary equipment
- 4" double ball bearing swivel casters



new!  
co-re  
caster™

### P-1100-SS

Anesthesia Table with Drawer

#### Overall Size

21<sup>3</sup>/<sub>8</sub>"W x 14"D x 34<sup>1</sup>/<sub>4</sub>"H

#### Trays

12<sup>5</sup>/<sub>8</sub>" W x 5<sup>5</sup>/<sub>8</sub>"D x 19<sup>5</sup>/<sub>8</sub>"H

#### Drawer

15<sup>3</sup>/<sub>8</sub>" W x 12<sup>1</sup>/<sub>2</sub>" D x 3<sup>1</sup>/<sub>4</sub>"H

#### features

- Ideal cart for storage of various instruments and supplies.
- Two removable stainless steel trays
- Towel bar and two mask hooks
- 2" double ball bearing swivel casters



### P-5090

Small Treatment Cabinet

#### Overall Size

16"W x 20"D x 33"H

#### Drawer

13<sup>1</sup>/<sub>2</sub>"W x 12"D x 3<sup>1</sup>/<sub>2</sub>"H

#### features

- Solid stainless steel retaining rail
- Internal shelf for optimal storage
- Optional locking rod
- 2" double ball bearing swivel casters



new!  
co-re  
caster™

### P-1105-SS

Anesthesia Cabinet with Drawers

#### Overall Size

19<sup>1</sup>/<sub>8</sub>"W x 15<sup>5</sup>/<sub>8</sub>"D x 33<sup>3</sup>/<sub>8</sub>"H

#### Upper 3 Drawers

13<sup>1</sup>/<sub>2</sub>"W x 12"D x 3<sup>1</sup>/<sub>2</sub>"H

#### Bottom Drawer

13<sup>1</sup>/<sub>2</sub>"W x 12"D x 7"H

#### features

- Provides extra storage space
- Full extending drawer hangers
- Removable 12<sup>5</sup>/<sub>8</sub>" x 19<sup>1</sup>/<sub>8</sub>" stainless steel tray
- 3" double ball bearing swivel casters



### P-5091

Large Treatment Cabinet

#### Overall Size

28"W x 18"D x 33"H

#### Top Drawers

21<sup>1</sup>/<sub>4</sub>"W x 16"D x 3<sup>1</sup>/<sub>4</sub>"H

#### Bottom Drawer

21<sup>1</sup>/<sub>4</sub>"W x 16"D x 5<sup>3</sup>/<sub>8</sub>"H

#### features

- Solid stainless steel retaining rail
- Internal shelf for optimal storage
- Optional locking rod
- 2" double ball bearing swivel casters



# sterile processing equipment



shown with hospital accessories

## CDS-3260

Central Supply work table

### Overall size

60"W x 32"D x 34"H

### features

- Stainless steel construction
- Height adjustable floor glides



shown with hospital accessories

## CDS-160

Instrument Container Wash Cart

### Overall size

49"W x 26"D x 67"H

### features

- Stainless steel construction
- Fully cart-washable
- Built to Steril-Gard specifications
- Fully welded frame
- Donut bumpers on legs
- 5" diameter stainless steel swivel casters
- Five stainless steel wire shelves
- Six adjustable container lid dividers

### Optional accessories

- 4" diameter swivel casters with brakes
- Sterile Wrap hangers measure 56"W x 30½"H
- Full-length lower shelf
- Tote box drawers:  
5" or 10" deep
- Stainless steel drawers:  
15½"W x 12½"D x 3½"H (installed, complete)



Caster with brake



stretcher series  
**P-172**  
 basic transport stretcher

The P-172 Series general transport stretcher provides an economical patient transport solution. This non-hydraulic stretcher series features a 1<sup>3</sup>/<sub>8</sub>" heavy-gauge O.D. tubular frame, continuous rubber bumper, long-life, double ball bearing, 8" swivel casters for quiet movement, and convenient hand holds on each corner.

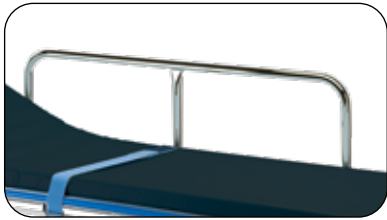

**RAIL SYSTEM**

Easy to wipe clean and disinfect side rails.

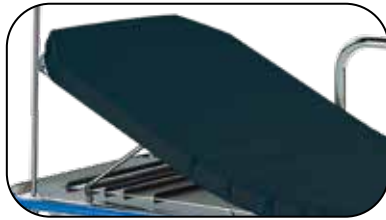

**FOWLER HEAD REST**

Fowler provides additional assistance for the safe and easy raising and lowering of the patient.

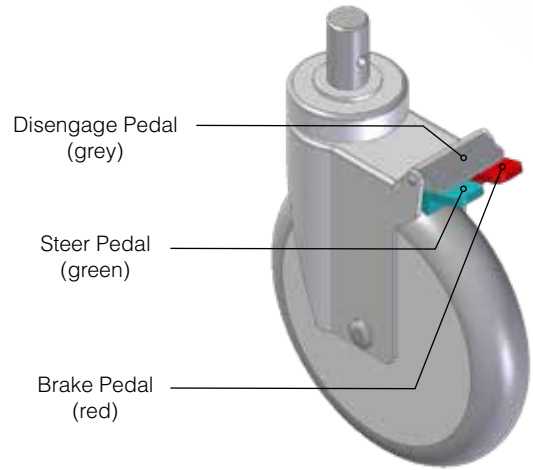

**CASTERS**



I.V. Poles Socket Locations

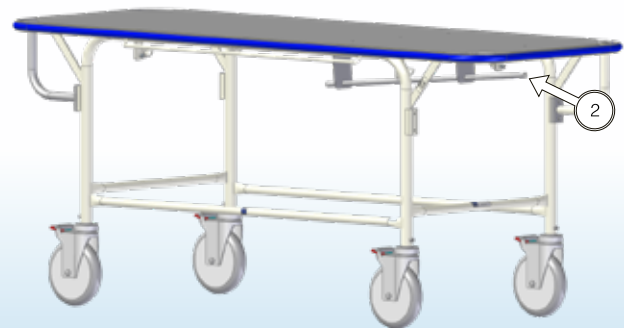

I.V. Pole Storage Tube Location

## STANDARD FEATURES

- 350 lbs. weight capacity
- Designed as a cost efficient transport stretcher
- Four Brake & Steer Casters
- Heavy-gauge, 1<sup>3</sup>/<sub>8</sub>" O.D. tubular frame
- Fixed litter top height
- Full perimeter bumper
- Convenient hand holds on each corner
- Long-life polyurethane, double ball bearing, 8" swivel casters for quiet movement
- Latex-free



## SPECIFICATIONS

Model Number	P-172
Weight Capacity	350 lbs. (159 kg)
Overall Length	78" (198 cm)
Overall Width	28" (71 cm)
Fixed Height	33 <sup>1</sup> / <sub>4</sub> " (85 cm)
<b>Optional Litter Positioning</b>	
Fowler Backrest	3°, 12°, 26°, 38°, 44°
Patient Surface	77" x 26" (196 x 66 cm)
Optional Side Rails	12" x 43" (30 x 109 cm)
Casters	8" (20 cm)
Warranty	1 year parts and labor

## P-172 CONFIGURATIONS

	Swivel Caster	Brake & Steer Caster	P-170-1 Shelf	P-170-2 Rails	P-170-3 Fowler	P-170-4 IV Pole	P-170-5 Strap	P-170-6 Bumpers	P-170-8 Mattress	P-170-9 O <sub>2</sub> Tank Holder
P-172		4								
P-172-C		4	•	•	•	•	•		•	•

## OPTIONS

Accessory	Accessory	Accessory
<b>Storage Shelf:</b> Shelf ..... P-170-1	<b>IV Pole:</b> Fixed Height ..... P-170-4	<b>Mattress:</b> Pad (2 <sup>1</sup> / <sub>2</sub> " thick black ) . P-170-8
<b>Side Rail:</b> Stainless Steel..... P-170-2	<b>Restraint Strap:</b> Velcro..... P-170-5	<b>O<sub>2</sub> Holder:</b> E Size Tank Holder ..... P-170-9 <i>(requires storage shelf P-170-1)</i>
<b>Fowler:</b> Stainless Steel..... P-170-3	<b>Rolling Bumpers:</b> 7 <sup>1</sup> / <sub>2</sub> " round rubber..... P-170-6	



### MATTRESS PAD

Soft-vinyl 2<sup>1</sup>/<sub>2</sub>" thick black mattress pad measures 26"W x 77"L.



### O<sub>2</sub> HOLDER

Bracket for E-size oxygen tank. Requires lower shelf.

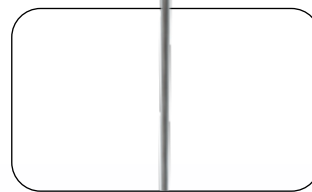

### IV POLE

Two hook pole includes holder and storage tube.

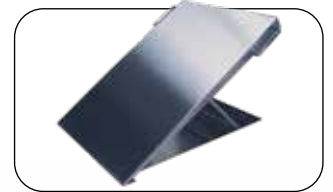

### FOWLER HEAD REST

Stainless steel construction with an adjustable range from 0° - 45°.

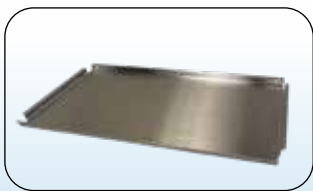

### LOWER SHELF

Stainless steel storage shelf.



### RESTRAINT STRAP

Blue Velcro restraint strap.



### CASTERS

8" double ball bearing casters.

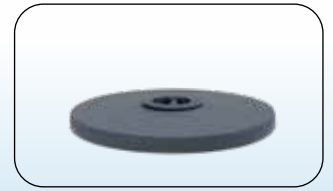

### BUMPERS

7<sup>1</sup>/<sub>2</sub>" rolling rubber bumpers



catalog 2024

