



2026

catalog



catalog download

TABLE OF CONTENTS

CARTS

- Revolution Case Carts.....2-3
- new!** • **GEN³** Case Carts.....4-5
- Sealed Case Carts6-7
- CartSTAT8
- new!** • **GEN³** Open Case.....9
- Open Carts - Utility10
- Open Carts - Central Supply11
- Open Carts - Distribution.....12-13
- Sterile Processing Cart.....14
- Accessories.....15-16

WARMING CABINETS

- Blanket & Fluid Warmers17-22

STANDS / KICKBUCKETS

- Mayo Stands.....23-24
- Basin Stands25
- Kick Buckets.....26
- Hampers.....27

new!

FOOTSTOOLS

- Footstools28

IV STANDS

- Stainless Steel29
- Infusion Pump Stand30-32
- new!** • Accessories.....33-34
- Element.....35-36

TABLES

- Space Station Two Tier Back Table37-39
- Instrument Assembly Station.....40
- Instrument Tables41
- Utility Tables42
- Central Supply Work Tables43
- Over-Operating Tables44

SEATING

- Stools and Chairs45-52

NURSERY

- Bassinets53-54

MISCELLANEOUS

- Wall Shelves & Operating Room Cabinets.....55-58
- Anesthesia and Treatment Cabinets59

STRETCHERS

- 172 Basic Stretchers60-61





RCC-242-B

Overall outside dimensions:
46¼"W x 27½"D x 42¼"H

Usable Interior Space
37¼"W x 23¾"D x 27¼"H

Double door, with scratch and impact resistant clear polycarbonate windows; glass-filled polymer push handles on each end; CartStat biohazard indicator wheel; re • volve™ 6" diameter, maintenance-free, high-temp, engineered thermoplastic casters, two direction and two total lock casters.

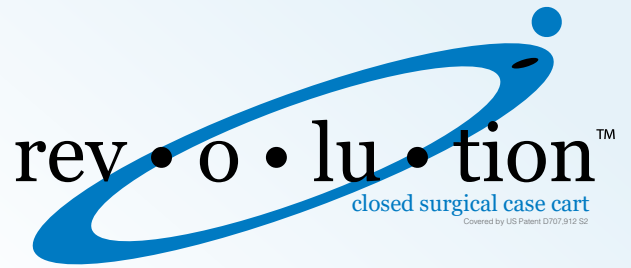

The **rev•o•lu•tion™** closed case cart is ergonomically designed to be lightweight and easy to handle, requiring less push/pull force than standard case carts.

Design

- Integrated body, floor and doors increases overall cart rigidity.
- Overall weight of cart reduced.
- Inside floor is sloped 1½° to the rear of cart to contain fluids.
- High temp, impact resistant bumper is mounted directly to the cart body to reduce overall footprint.
- Roll-out shelves with two position latch mechanism safely locks the shelf in or out.
- Cart is designed to quickly drain during cart washing to minimize residual water.



**RCC-233-B****Overall outside dimensions:**
29"W x 27½"D x 59"H**Usable Interior Space**
20"W x 23¾"D x 44¾"H

Single door, with scratch and impact resistant clear polycarbonate windows; glass-filled polymer push handles on each end; CartStat biohazard indicator wheel; re • volve™ 6" diameter, maintenance-free, high-temp, engineered thermoplastic casters, two direction and two total lock casters.

**RCC-235-B****Overall outside dimensions:**
36"W x 27½"D x 59"H**Usable Interior Space**
27"W x 23¾"D x 44¾"H

Double door, with scratch and impact resistant clear polycarbonate windows; glass-filled polymer push handles on each end; CartStat biohazard indicator wheel; re • volve™ 6" diameter, maintenance-free, high-temp, engineered thermoplastic casters, two direction and two total lock casters.

**RCC-245-B****Overall outside dimensions:**
46¼"W x 27½"D x 59"H**Usable Interior Space**
37¼"W x 23¾"D x 44¾"H

Double door, with scratch and impact resistant clear polycarbonate windows; glass-filled polymer push handles on each end; CartStat biohazard indication wheel; re • volve™ 6" diameter, maintenance-free, high-temp, engineered thermoplastic casters, two direction and two total lock casters.

**RCC-256-MS-B****Overall outside dimensions:**
29"W x 27½"D x 42¼"H**Usable Interior Space**
20"W x 23¾"D x 27¾"H

Single door, with scratch and impact resistant clear polycarbonate window; glass-filled polymer push handles on each end; CartStat biohazard indicator wheel; re • volve™ 6" diameter, maintenance-free, high-temp, engineered thermoplastic casters, two direction and two total lock casters.

Shelving Configurations

RCC-333-WS..... Wire shelf, for RCC-233-B and RCC-256-MS-B.**RCC-333-SS**..... Solid shelf, for RCC-233-B and RCC-256-MS-B.**RCC-333-WSRO** .. Roll-out wire shelf, with (2) position spring loaded shelf lock. Shelf locks in storage and fully extended position for RCC-233-B and RCC-256-MS-B.**RCC-333-SSRO** ... Roll-out solid shelf, with (2) position spring loaded shelf lock. Shelf locks in storage and fully extended position for RCC-233-B and RCC-256-MS-B.**RCC-335-WS**..... Wire shelf, for RCC-235-B.**RCC-335-SS**..... Solid shelf, for RCC-235-B.**RCC-335-WSRO** .. Roll-out wire shelf, with (2) position spring loaded shelf lock. Shelf locks in storage and fully extended position, for RCC-235-B.**RCC-335-SSRO** ... Roll-out solid shelf, with (2) position spring loaded shelf lock. Shelf locks in storage and fully extended position, for RCC-235-B.**RCC-342-WS**..... Wire shelf, for RCC-242-B and RCC-245-B.**RCC-342-SS**..... Solid shelf, for RCC-242-B and RCC-245-B.**RCC-342-WSRO** .. Roll-out wire shelf, with (2) position spring loaded shelf lock. Shelf locks in storage and fully extended position, for RCC-242-B and RCC-245-B.**RCC-342-SSRO** ... Roll-out solid shelf, with (2) position spring loaded shelf lock. Shelf locks in storage and fully extended position, for RCC-242-B and RCC-245-B.



CDS-356-LD shown with optional shelf

CDS-356-LD-B

Overall outside dimensions:
29½"W x 28⅛"D x 30"H

Usable Interior Space
20"W x 24¼"D x 18¼"H

One shelf configuration recommended



CDS-356-MS shown with optional shelf

CDS-356-MS-B

Overall outside dimensions:
29½"W x 28⅛"D x 39"H

Usable Interior Space
20"W x 24¼"D x 27¼"H

One shelf configuration recommended

case carts
surgical

features

- Stainless steel construction.
- Integrated body and floor increases overall cart rigidity.
- High temp, impact resistant bumper mounted directly to cart body reducing the overall footprint.
- Cool-Touch polymer handle.
- 6" diameter stainless steel casters.
- Biohazard Indicator Wheel standard.
- CDS-342 and CDS-345 feature two direction lock casters.
- Roll-out shelves with two position latch mechanism safely locks the shelf in or out.
- Cart is designed to quickly drain during cart washing to minimize residual water.

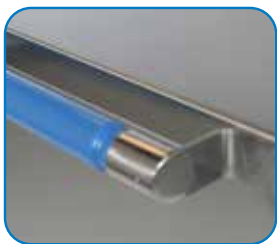

Cool-Touch Handle



Biohazard Indicator Wheel
CartStat



Modular Bumper



Waterfall Wire Shelf



re·volve™
caster upgrade



CDS-335 shown with optional shelves

CDS-333-B

Overall outside dimensions:
29½"W x 28⅛"D x 56"H

Usable Interior Space
20"W x 24¼"D x 44¼"H

Two shelf configuration recommended

CDS-335-B

Overall outside dimensions:
35"W x 32¾"D x 56"H

Usable Interior Space
25½"W x 28¾"D x 44¼"H

Two shelf configuration recommended

CDS-342-B

Overall outside dimensions:
46¾"W x 28⅛"D x 39"H

Usable Interior Space
37¼"W x 24¼"D x 27¼"H

One shelf configuration recommended

CDS-345-B

Overall outside dimensions:
46¾"W x 28⅛"D x 56"H

Usable Interior Space
37¼"W x 24¼"D x 44¼"H

Two shelf configuration recommended

Shelving Configurations

CDS-333-SS Stainless steel solid shelf for CDS-333, CDS-356-LD and CDS-356-MS.

CDS-333-SSRO ... Stainless steel roll-out solid shelf for CDS-333, CDS-356-LD and CDS-356-MS.

CDS-333-WS Stainless steel wire shelf for CDS-333, CDS-356-LD and CDS-356-MS.

CDS-333-WSRO .. Stainless steel roll-out wire shelf for CDS-333, CDS-356-LD and CDS-356-MS.

CDS-335-SS Stainless steel solid shelf for CDS-335.

CDS-335-SSRO ... Stainless steel roll-out solid shelf for CDS-335.

CDS-335-WS Stainless steel wire shelf for CDS-335.

CDS-335-WSRO .. Stainless steel roll-out wire shelf for CDS-335.

CDS-342-SS Stainless steel solid shelf for CDS-342 and CDS-345.

CDS-342-SSRO ... Stainless steel roll-out solid shelf for CDS-342 and CDS-345.

CDS-342-WS Stainless steel wire shelf for CDS-342 and CDS-345.

CDS-342-WSRO .. Stainless steel roll-out wire shelf for CDS-342 and CDS-345.

Custom CDS carts engineered to customer specifications available upon request.



SCC-256-MS shown with optional drop leaf

SCC-256-MS

Overall outside dimensions:
28⁵/₈"W x 28⁵/₈"D x 39⁷/₈"H

Usable Interior Space
20¹/₄"W x 24"D x 26¹/₄"H

One shelf configuration recommended

sealed carts

surgical

features

Sealed Case Carts features a full seal around the door perimeter and center stop providing an added level of protection against dust and debris.

- Fully-welded all stainless steel construction
- Exterior push handles for better control and more interior space
- One-piece continuous wrap-around bumper, non-marring
- Sound-deadened tops and doors for quiet operation
- Positive lock door latches
- All carts can be manufactured to individual specifications



Biohazard Indicator Wheel
CartStat



Sealed Case Cart Option



Heavy Duty Casters
Option



Floor Sloped Toward Rear
2° slope for containment of fluid.



Total Lock Brake
Option



Shown with optional shelves & CartStat

Shown with optional shelf

Shown with optional shelves

SCC-233

Overall outside dimensions:
28⁵/₈"W x 28⁵/₈"D x 56⁷/₈"H

Usable Interior Space
20¹/₄"W x 24"D x 43¹/₄"H

Two shelf configuration recommended

SCC-235

Overall outside dimensions:
34¹/₈"W x 32³/₈"D x 56⁷/₈"H

Usable Interior Space
25³/₄"W x 27³/₄"D x 43¹/₄"H

Two shelf configuration recommended

SCC-242

Overall outside dimensions:
45⁷/₈"W x 28⁵/₈"D x 39⁷/₈"H

Usable Interior Space
37¹/₂"W x 24"D x 26¹/₄"H

One shelf configuration recommended

SCC-245

Overall outside dimensions:
45⁷/₈"W x 28⁵/₈"D x 56⁷/₈"H

Usable Interior Space
37¹/₂"W x 24"D x 43¹/₄"H

Two shelf configuration recommended

OPTIONAL FEATURES

- Security Latch
- Heavy Duty 6" x 2" Casters
- Color Identification Wheel
- Barcode Plate Holder
- 8¹/₂" x 11" Card Holder

Shelving Configurations

CDS-233-SS..... Stainless steel solid shelf for SCC-233 and SCC-256-MS.

CDS-233-SSRO ... Stainless steel roll-out solid shelf for SCC-233 and SCC-256-MS.

CDS-233-WS..... Stainless steel wire shelf for SCC-233 and SCC-256-MS.

CDS-233-WSRO .. Stainless steel roll-out wire shelf for SCC-233 and SCC-256-MS.

CDS-235-SS..... Stainless steel solid shelf for SCC-235.

CDS-235-SSRO ... Stainless steel roll-out solid shelf for SCC-235.

CDS-235-WS..... Stainless steel wire shelf for SCC-235.

CDS-235-WSRO .. Stainless steel roll-out wire shelf for SCC-235.

CDS-242-SS..... Stainless steel solid shelf for SCC-242 and SCC-245.

CDS-242-SSRO ... Stainless steel roll-out solid shelf for SCC-242 and SCC-245.

CDS-242-WS..... Stainless steel wire shelf for SCC-242 and SCC-245.

CDS-242-WSRO .. Stainless steel roll-out wire shelf for SCC-242 and SCC-245.

Custom SCC carts engineered to customer specifications available upon request.



CartStat

Ensure safe transport and compliance

- Designed for compliance with OSHA standard CFR 1910.1030, ANSI/AAMI ST 79.
- Clearly communicate the contents and destination of the cart - supports staff safety and sterility.
- **CartStat** wheel mounts directly on the cart so you always provide safe transportation of instruments.

Options:

Biohazard Indicators

- RCC-BH
- CDS-BH



CartStat

Clearly communicate the contents and destination of the cart - supports staff safety and sterility. Designed for compliance with OSHA standard CFR 1910.1030, ANSI/AAMI ST 79.

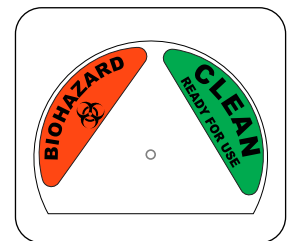

Biohazard Indicator Wheel



CDS-362 Procedure Cart

cart shown with optional wire back and shelves

Overall Size

29⁵/₈"W x 29⁵/₈"D x 65¹/₂"H

- Designed to be used as a surgical or obstetrical case cart
- Shelves adjustable on four inch spacing intervals
- Multi-purpose cart can also be used as a linen cart or as a clean/dirty utility cart

Weight Capacity:

Individual Shelf 150 lbs.
 Bottom Shelf 200 lbs.
 Maximum Cart Capacity ... 600 lbs.



CDS-353 Cart

Overall Size

35³/₈"W x 26¹/₈"D x 36¹/₂"H

- Equipped with rails on the all three surfaces
- Adjustable stainless steel center shelf (Three levels with 5¹/₂" intervals)

Weight Capacity:

Top Shelf 150 lbs.
 Middle Shelf 150 lbs.
 Bottom Shelf 200 lbs.
 Maximum Cart Capacity ... 500 lbs.



CDS-353-HD Heavy-Duty Utility Cart

Overall Size

35³/₈"W x 26¹/₈"D x 45"H

Weight Capacity:

Top 250 lbs.
 Middle 250 lbs.
 Bottom 400 lbs.

Maximum Load 900 lbs.

optional brake casters available

open case carts

features

- All welded stainless steel construction for one single piece frame
- Frame tubing is 1¹/₄" - 18 gauge stainless steel
- Bolt-on bumper system for easy cleaning and replacement
- 6" stainless steel casters
- Solid stainless steel 16 gauge bottom
- **Options:**
 Wire backing (2" x 3" or 4" x 6" configuration)



CDS-145 Utility Cart

Overall Size

41½"W x 23¾"D x 38¼"H

Weight Capacity:

Top 50 lbs.

Middle 50 lbs.

Bottom 100 lbs.

Maximum Load 200 lbs.

5" stainless steel plated casters

open carts

features

- All welded stainless steel construction for one single piece frame
- Easy to clean
- Strong, fully welded construction



CDS-140 Light Weight Utility Cart

Overall Size

27½"W x 18⅞"D x 40"H

Weight Capacity:

Top 25 lbs.

Middle 25 lbs.

Bottom 50 lbs.

Maximum Load 100 lbs.

4" nickel plated casters



CDS-140-B Light Weight Utility Cart

Overall Size

27½"W x 18⅞"D x 40"H

Weight Capacity:

Top 25 lbs.

Middle 25 lbs.

Bottom 50 lbs.

Maximum Load 100 lbs.

4" nickel plated casters

5" rolling bumpers



CDS-377 Central Supply Cart

Overall Size

55½"W x 26⅞"D x 53½"H

Includes seven 5" deep tote boxes (standard), or up to three large 10" deep tote boxes

Weight Capacity:

Individual Shelf..... 100 lbs. (option)
 Bottom 200 lbs.

Maximum Cart Capacity ... 600 lbs.



CDS-378 Central Supply Cart

Overall Size

66¾"W x 26⅞"D x 65½"H

Includes nine 5" deep tote boxes (standard), or up to four large 10" deep tote boxes

Weight Capacity:

Individual Shelf..... 100 lbs. (option)
 Bottom 200 lbs.

Maximum Cart Capacity ... 600 lbs.

open carts

features

- All welded stainless steel construction for one single piece frame
- Plate-mounted 6" stainless steel casters with two diagonal swivel locks to provide steering stability
- Bolt-on bumper system for easy cleaning and replacement

Options:

Wire or solid shelving, dividers, tote boxes, caster upgrade and wire backing (2" x 3" or 4" x 6" configuration)



CDS-378 cart shown with optional accessories



CDS-347-A Distribution Cart

Overall Size

39³/₈"W x 26¹/₈"D x 53¹/₂"H

- Designed to be used as a clean/dirty linen cart or as a large utility cart.

Weight Capacity:

Shelf..... 100 lbs. (optional)

Bottom 200 lbs.

Maximum Cart Capacity ... 425 lbs.



CDS-347 Distribution Cart

Overall Size

39³/₈"W x 26¹/₈"D x 41¹/₂"H

- Ideal for case cart systems or general floor use.

Weight Capacity:

Individual Shelf..... 75 lbs. (option)

Bottom 200 lbs.

Maximum Cart Capacity ... 425 lbs.

open carts

features

- All welded stainless steel construction for one single piece frame
- Frame tubing is 1¹/₄" - 18 gauge stainless steel
- Bolt-on bumper system for easy cleaning and replacement
- Shelves adjustable on four inch spacing intervals
- Plate-mounted 6" stainless steel casters
- Solid 16 gauge stainless steel bottom
- **Options:**
Wire or solid shelving, dividers, tote boxes, caster upgrades, and wire backing (2" x 3" or 4" x 6" configuration)



Swivel Plate Caster





CDS-348-A Distribution Cart

Overall Size

50 $\frac{5}{8}$ "W x 26 $\frac{1}{8}$ "D x 65 $\frac{1}{2}$ "H

- Designed to be used as a clean/dirty linen cart or as a large utility cart

Weight Capacity:

Shelf..... 100 lbs. (optional)

Bottom 200 lbs.

Maximum Cart Capacity ... 600 lbs.

open carts

features

- All welded stainless steel construction for one single piece frame
- Frame tubing is 1 $\frac{1}{4}$ " - 18 gauge stainless steel
- Bolt-on bumper system for easy cleaning and replacement
- Shelves adjustable on 4 inch spacing intervals
- Plate-mounted 6" stainless steel casters with two diagonal swivel locks to provide steering stability
- Solid 16 gauge stainless steel bottom
- **Options:**
Wire or solid shelving, dividers, tote boxes, caster upgrades, and wire backing (2" x 3" or 4" x 6" configuration)



CDS-348 General Utility Cart

Overall Size

50 $\frac{5}{8}$ "W x 26 $\frac{1}{8}$ "D x 53 $\frac{1}{2}$ "H

- Suitable for general floor service, pharmacy or linen

Weight Capacity:

Shelf..... 100 lbs. (option)

Bottom 200 lbs.

Maximum Cart Capacity ... 600 lbs.



CDS-349 General Utility Cart

Overall Size

60 $\frac{3}{8}$ "W x 26 $\frac{1}{8}$ "D x 65 $\frac{1}{2}$ "H

- Ideal cart for linen distribution, storage and floor nursing stations

Weight Capacity:

Shelf..... 100 lbs. (option)

Bottom 200 lbs.

Maximum Cart Capacity ... 600 lbs.



CDS-349 cart shown with optional accessories



shown with hospital accessories

CDS-160 Instrument Container Wash Cart

Overall Size

49"W x 26"D x 67"H

Weight Capacity:

Shelf..... 80 lbs.

Bottom 120 lbs.

Maximum Cart Capacity ...360 lbs.



shown with optional stainless steel wire shelves

CDS-151 Sterilizer Cart

Overall Size

37³/₄"W x 24¹/₂"D x 55³/₈"H (includes bumpers)

sterile processing equipment

features

- Stainless steel construction
- Fully cart-washable
- Fully welded frame
- Donut bumpers on legs
- 5" diameter stainless steel swivel casters
- Five stainless steel wire shelves
- Six adjustable container lid dividers

Options:

- Wrap hangers measure 56"W x 30¹/₂"H
- Full length lower shelf
- Tote box drawers: 5" or 10" deep
- Stainless steel drawers:
15¹/₂"W x 12¹/₂"D x 3¹/₂"H (installed, complete)
- 4" diameter swivel casters with brakes

sterilizer cart

An excellent cart for autoclaves due to single piece, all welded stainless steel construction

features

- Fully-welded seams
- Heavy-duty 1¹/₄" diameter tubular frame
- 5" high temperature stainless steel swivel plate casters for smooth mobility
- High temperature corner bumpers
- Open wire bottom for improved steam circulation
- 17¹/₂" center-to-center caster spacing

open cart accessories



Shelf Dividers

- Adjustable
- Stainless steel construction for durability and ease of maintenance
- Available for solid or wire shelves in 6" or 10" height

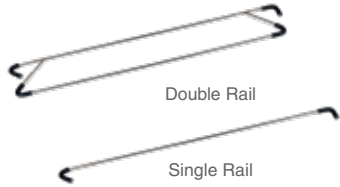

Retaining Rails

- Retaining rails to prevent accidental loss of materials
- Easily attached or removed
- Sound deadening rubber sleeve
- Polished stainless steel ($\frac{5}{16}$ " diameter)

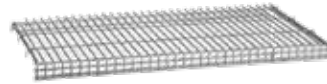

Wire Shelves

- Electro-polished stainless steel
- Easy to adjust or remove
- $\frac{3}{16}$ " diameter wire welded to $\frac{1}{4}$ " diameter wire support rods
- Maximum opening between rods: 1" x $8\frac{3}{4}$ "



Solid Shelves

- Steril-Gard construction
- Easy to adjust or remove
- 18-gauge stainless steel

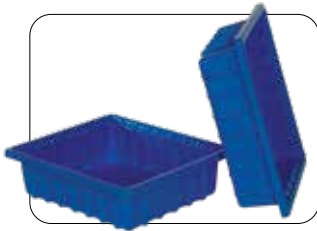

5" Tote Box Drawers

- Constructed of impact-resistant, high-density polyethylene for durability
- Optional short or long tote box dividers available

DIMENSIONS:

17 $\frac{3}{4}$ "L x 14 $\frac{1}{2}$ "W x 51/8"D



Tote mounted with hanger

10" Tote Box Drawers

- Constructed of impact-resistant, high-density polyethylene for durability
- Optional short or long tote box dividers available

DIMENSIONS:

17 $\frac{3}{4}$ "L x 14 $\frac{1}{2}$ "W x 10"D

Tote Box Hangers

- Hangs below both wire or solid shelving



Stainless Steel Caster

Stainless Steel Casters

- All stainless steel material and bearings for a rust-free caster
- Two lubrication points for ease of maintenance

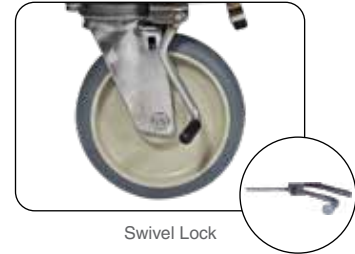

Swivel Lock

Swivel Lock

- Used for improved steering
- Recommended for long carts to assist in navigating long corridors
- Disengage swivel lock for maneuverability in tight spaces
- Easy foot operation



Automatic Couplers

- Cart couplers are available for installation on all open carts
- Compatible with any major elevator or cart washer with automatic cart pickup system



Heavy-Duty Covers

- Heavy duty, anti-bacterial STAPH-CHEK™ covers protect cart and its cargo
- Flame-resistant
- Clear vinyl front with heavy-duty nylon zippers or Velcro closures
- Hand clean with soap and warm water ONLY. Do not launder.



Disposable Cart Covers

- Heavy, clear plastic material
- Can serve as a trash bag after completion of the procedure
- Packed on convenient rolls
- Economical, single-use alternative to washable covers



Wire Backs

- Electro-polished stainless steel
- $\frac{3}{16}$ " diameter vertical wires, welded to $\frac{1}{4}$ " diameter horizontal rods
- Choice of 2" x 3" or 4" x 6" openings

closed cart accessories



Safety Release Leaf Lock Button



Total Lock



Swivel Lock



Stainless Steel Caster

Drop Leaf Shelves

- Extends top of cart to increase work surface area
- Drain holes at end of leaf
- Features Safety Release Leaf Lock Button

High Temp Caster

- Maintenance-free caster
- Recommended for high temp cart wash environments
- Precision sealed stainless steel swivel & wheel bearings
- High-temp rubber tread donut shaped wheel

Swivel Lock

- Used for improved steering
- Recommended for long carts to assist in navigating long corridors
- Disengage swivel lock for maneuverability in tight spaces
- Easy foot operation

Stainless Steel Casters

- All stainless steel material and bearings for a rust-free caster
- Two lubrication points for ease of maintenance



Automatic Couplers

- Cart couplers are available for installation on all closed carts
- Compatible with any major elevator or cart washer with automatic cart pick up system



Wire Shelves

- Stainless steel
- Easy to adjust or remove
- 3/16" diameter wire welded to 5/16" diameter wire support rods
- Maximum opening between rods: 1 5/16" x 7 11/16"



Solid Shelves

- Steril-Gard construction
- Easy to adjust or remove
- 18-gauge stainless steel



Card Holder

- Standard card sizes include:
 - 4" x 6"
 - 5" x 7"
 - 8 1/2" x 11"
- Available in any size or orientation to suit individual needs



Cart ID Systems

- For easy cart identification
- High-visibility Lexan material
- Cart washable
- Custom labels available upon request (5/16" diameter)



CartStat

- **CartStat** wheel mounts directly on the cart.
- Designed for compliance with OSHA standard CFR 1910.1030, ANSI/AAMI ST 79.
- May be mounted in the field.



Exterior Security Latch

- Prevents unintentional opening of cart doors
- Available with hole to fit customer provided tamper proof tags



Tamper Proof Tag



Security Paddle Latch

- Easy to add in field - no drilling required
- Flush mount - does not extend beyond door face
- Integrated to paddle latch



Tote Box Drawers

- Constructed of impact-resistant high density polyethylene for durability
- Available in 5" or 10" sizes
- Optional short or long tote box dividers available to section drawer into smaller compartments

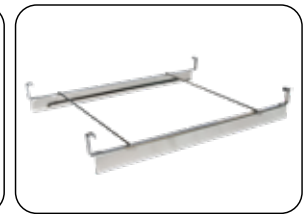

Tote Box Hangers

- Stainless steel hangers hold totes below top of the cart
- Attaches to either wire or solid shelving

tri-mode
new!



P-2420

OVERALL SIZE

30"W x 21.12"D x 25.12"H

COMPARTMENT SIZE

- 4.75 cubic ft.
- 26.5"W x 17"D x 18.25"H

- **tri-mode Range:**
 - Irrigation: 90°F - 150°F
 - Injection: 90°F - 104°F
 - Blanket: 90°F - 160°F
- **Total Capacity:**
 - 20 1-liter bags or
 - 24 1-liter bottles
 - 14 - 18 blankets
- Caster (Option)

tri-mode
new!



P-2430

OVERALL SIZE

30"W x 28.5"D x 25.12"H

COMPARTMENT SIZE

- 5.5 cubic ft.
- 26.5"W x 19.75"D x 18.25"H

- **tri-mode Range:**
 - Irrigation: 90°F - 150°F
 - Injection: 90°F - 104°F
 - Blanket: 90°F - 160°F
- **Total Capacity:**
 - 48 1-liter bags or
 - 30 1-liter bottles
 - 16 - 20 blankets
- Caster (Option)

warming cabinets

blanket & fluid

features

Combination warmers P-2420 and P-2430, feature **tri-mode** chamber allowing for 3 different modes of warming, LED display, window doors, and control lock programming.

Blanket warmers P-2010-S, P-2012, P-2022 and P-2032 feature a LED display, window doors, and control lock programming.



solid door

P-2010-S

OVERALL SIZE

16.5"W x 25.25"D x 21.5"H

COMPARTMENT SIZE

- 2.3 cubic ft.
- 13.25"W x 21.25"D x 14"H

- **Temp Range:**
 - Blankets: 98°F - 200°F
- **Total Capacity:**
 - 5 - 7 blankets
- No fans or lint traps
- Caster (Option)



P-2012

OVERALL SIZE

18.5"W x 23.5"D x 22"H

COMPARTMENT SIZE

- 2.5 cubic ft.
- 15.5"W x 18.75"D x 15.25"H

- **Temp Range:**
 - Blanket: 90°F - 160°F
- **Total Capacity:**
 - 4 - 6 blankets
- No fans or lint traps
- Caster (Option)

heated center
shelf



P-2022

OVERALL SIZE

18.5"W x 23.5"D x 32.25"H (w/ casters)
18.5"W x 23.5"D x 28"H

COMPARTMENT SIZE

- 3.5 cubic ft.
 - 15.5"W x 18.75"D x 21.25"H*
- * (9.56"H above and below the center shelf)

- **Temp Range:**
 - Blanket: 90°F - 160°F
- **Total Capacity:**
 - 10 - 12 blankets
- No fans or lint traps
- Caster (Option)

shown with left door
hidge mount option



P-2032

OVERALL SIZE

24"W x 25.75"D x 39.25"H (w/ casters)
24"W x 25.75"D x 35"H

COMPARTMENT SIZE

- 7.5 cubic ft.
 - 21"W x 21.75"D x 28.25"H
- * (13.18"H above and below the centershelf)

- **Temp Range:**
 - Blanket: 90°F - 160°F
- **Total Capacity:**
 - 20 - 25 blankets
- No fans or lint traps
- Caster (Option)



P-2040

OVERALL SIZE (without bumper)

22"W x 34.25"D x 72.5"H

COMPARTMENT SIZE

- 7.7 cubic ft. upper
- 19"W x 26.5"D x 26.75"H
- 7.7 cubic ft. lower
- 19"W x 26.25"D x 26.75"H

- **Temp Range:**
 - Blankets: 90°F - 160°F
 - Irrigation: 90°F - 150°F
- **Total Capacity:**
 - 60 1-liter bottles
 - 40-50 blankets
- Two compartments, each with individual controls
- No fans or lint traps
- 5" casters
- Bumper (Option)

warming cabinets

blanket & fluid

features

Combination fluid and blanket warmers feature LED display, window doors, and control lock programming.

- Two compartments, each with individual controls



P-2147

OVERALL SIZE

- 30"W x 28.5"D x 75"H (caster standard)
- 30"W x 28.5"D x 68"H (feet - option)

COMPARTMENT SIZE

- 5.5 cu. ft. fluid compartment
- 26.5"W x 23.75"D x 15"H
- 13 cu. ft. blanket compartment
- 26.5"W x 23.75"D x 36"H

- **tri mode Range:**
 - Blankets: 90°F - 160°F
 - Irrigation: 90°F - 150°F
 - Injection: 90°F - 104°F
- **Total Capacity:**
 - 24 1-liter bags
 - 30 1-liter bottles
 - 10-14 blankets (upper chamber)
 - 30-40 blankets (lower chamber)
- Separate temperature controls for each compartment (**tri mode** top chamber only)
- Two compartments with two separate doors
- 5" casters



P-2150

OVERALL SIZE

- 30"W x 21.25"D x 75"H

COMPARTMENT SIZE

- 3.9 cu. ft. fluid compartment
- 26.5"W x 17"D x 15"H
- 9.4 cu. ft. blanket compartment
- 26.5"W x 17"D x 36"H

- **tri mode Range:**
 - Blankets: 90°F - 160°F
 - Irrigation: 90°F - 150°F
 - Injection: 90°F - 104°F
- **Total Capacity:**
 - 20 1-liter bags
 - 24 1-liter bottles
 - 9-12 blankets (upper chamber)
 - 24-30 blankets (lower chamber)
- Separate temperature controls for each compartment (**tri mode** top chamber only)
- Two compartments with two separate doors
- Pass Through (Option)



P-2055

OVERALL SIZE

32"W x 29.25"D x 71"H

COMPARTMENT SIZE

- 20.6 cubic ft.
- 26.5"W x 23.75"D x 56.75"H

- **Temp Range:**
 - Blankets: 90°F - 160°F
- **Total Capacity:** 60-70 blankets
- One compartment, two separate doors
- Circulation fan for even temperature
- 5" casters
- Feet (Option)

warming cabinets

blanket

features

Elite Series blanket warmers feature windowed door, programmable control with temperature lock and four digit LED display and single pane energy efficient coated glass window door allows inventory observation.

WarmSafe™
technology

Heated center shelf



P-2210

OVERALL SIZE

• 18.5"W x 22"D x 22"H

COMPARTMENT SIZE

- 2.5 cubic ft.
- 15.5"W x 18.75"D x 15.25"H

- **Temp Range:**
 - Blankets: 90°F - 160°F
- A warming shut-off system, separate from the electronic control, prevents overheating
- Interior blue lighting
- No fans or lint traps
- Caster (Option)



P-2220

OVERALL SIZE

• 18.5"W x 22"D x 28"H

COMPARTMENT SIZE

- 3.5 cubic ft.
- 15.5"W x 18.75"D x 21.25"H*
* (9.56"H above & below the center shelf)

- **Temp Range:**
 - Blankets: 90°F - 160°F
- A warming shut-off system, separate from the electronic control, prevents overheating
- Interior blue lighting
- No fans or lint traps
- Caster (Option)



P-2230

OVERALL SIZE

• 24"W x 24.5"D x 22"H

COMPARTMENT SIZE

- 4 cubic ft.
- 21"W x 21.75"D x 15.25"H

- **Temp Range:**
 - Blankets: 90°F - 160°F
- A warming shut-off system, separate from the electronic control, prevents overheating
- Interior blue lighting
- No fans or lint traps
- Caster (Option)

Heated center shelf



P-2240

OVERALL SIZE

• 24"W x 24.25"D x 35"H

COMPARTMENT SIZE

- 7.5 cubic ft.
- 21"W x 21.75"D x 28.25"H*
* (13.12"H above & below the center shelf)

- **Temp Range:**
 - Blankets: 90°F - 160°F
- A warming shut-off system, separate from the electronic control, prevents overheating
- Interior blue lighting
- No fans or lint traps
- Caster (Option)



P-2112

OVERALL SIZE

18.5"W x 23.5"D x 22"H

COMPARTMENT SIZE

- 2.5 cubic ft.
- 15.5"W x 18.75"D x 15.25"H

- **Temp Range:**
 - Irrigation: 90°F - 150°F
 - Injection: 90°F - 104°F
- **Total Capacity:**
 - 16 1-liter bags or
 - 12 1-liter bottles
- Glide out basket
- Casters (option)



P-2122

OVERALL SIZE

18.5"W x 23.5"D x 28"H

COMPARTMENT SIZE

- 3.5 cubic ft.
- 15.5"W x 18.75"D x 21.25"H

- **Temp Range:**
 - Irrigation: 90°F - 150°F
 - Injection: 90°F - 104°F
- **Total Capacity:**
 - 24 1-liter bags or
 - 24 1-liter bottles
- Glide out basket
- Casters (option)

warming cabinets

fluid

features

Fluid warmers feature 4 digit LED display, window doors, programmable temperature control and interior lighting.

Fluid warmers incorporate the use of a circulation fan to evenly distribute the warmed air to achieve and maintain accurate set-point temperatures.

Pedigo fluid warmers have an accuracy of +0/-2°F for injection fluids and an accuracy of +0/-3°F for irrigation fluids.



shown with the P-2010-S warmer

P-2010-TC

OVERALL SIZE

23.25"W x 32.25"D x 43"H

features

- Stainless steel
- 4" casters with brake & swivel lock
- 300 lbs. total weight capacity at 100 lbs. per shelf
- Shelf Dimensions 17"W x 27"D x 12¼"H
- Compatible with the P-2010-S warming cabinet



P-2030-TC

OVERALL SIZE

26"W x 33"D x 28"H

features

- Stainless steel
- 4" stainless steel casters with brakes
- 400 lbs. total weight capacity at 200 lbs. per shelf
- Top shelf
- Bottom shelf with 4-sided rail.
- Compatible with the P-2032, P-2230 and P-2240 warming cabinets

WarmSafe™
technology



P-2010-CB

OVERALL SIZE

21.25"W x 29.35"D x 6.81"H

features

- Platform
- 4" stainless steel casters with brakes
- 350 lbs. total weight capacity
- Perimeter bumper
- Cutouts in platform capture warming cabinet feet.
- Compatible with the P-2010-S warming cabinet

warming cabinet features



Fluid Warmers

- **WarmSafe™ Technology**
- Safety coated interior
- Fully insulated
- 120 VAC
- Heavy duty hardware
- Glass door
- Perimeter bumper (P-2130 only)

Safety Features

- Built-in speaker for audible feedback
- Safety override feature prevents overheating
- Lockout feature

Options

- Optional left hand door swing available
- Option of casters or fixed legs

Warranty

- One Year Service
- Three Years on Parts
- Lifetime Technical Support



Models

- P-2112
- P-2122
- P-2130



Blanket Warmers

- **WarmSafe™ Technology**
- Safety coated interior
- Fully insulated
- 120 VAC
- Heavy duty hardware
- Glass door (P-2010-S solid door)

Safety Features

- Built-in speaker for audible feedback
- Safety override feature prevents overheating
- Lockout feature (Not available on P-2010-S)

Options

- Optional left hand door swing available (Not available on P-2010-S)
- Option of casters or fixed legs
- Perimeter bumper is optional (excludes P-2055)

Warranty

- One Year Service
- Three Years on Parts
- Lifetime Technical Support



- P-2010-S
- P-2012
- P-2022
- P-2032
- P-2040
- P-2055
- P-2210
- P-2220
- P-2230
- P-2240



Blanket & Fluid Warmers

- **WarmSafe™ Technology**
- **tri mode**
- Safety coated interior
- Fully insulated
- 120 VAC
- Heavy duty hardware
- Glass or solid door

Safety Features

- Built-in speaker for audible feedback
- Safety override feature prevents overheating
- Lockout feature

Options

- Optional left hand door swing available
- Option of casters or fixed legs (excludes P-2150)
- Optional pass through warmer (P-2150 only)

Warranty

- One Year Service
- Three Years on Parts
- Lifetime Technical Support



Models

- P-2147
- P-2150
- P-2420
- P-2430



Modular Configuration

- Wall mount:
One to six (1-3) bag capacity
- Countertop:
One to three (1-3) bag capacity
- Pole mount:
One to three (1-3) bag capacity

Temperature:

- Heats to 104°F (40°C) in 30 minutes or less (slightly longer heating time is required for 3L bags)
- Accuracy of +0°/-2°C (+0°/-3°F)

Electronic Control

Monitors the length of time the bag has been held at temperature, displayed additionally by a status button. The control alerts users when a fluid bag has been held at temperature longer than 14 days.

* All units have universal IEC 320 C14 power input, 120/220/230VAC

Warranty

1 year parts and labor



ivNow-1

P-2301-A

Capacity

One bag, up to 3ℓ



ivNow-2

P-2302-A

Capacity

Two bags, up to 3ℓ



ivNow-3

P-2303-A

Capacity

Three bags, up to 3ℓ



ivNow®

individual warming pods

features

The ivNow® fluid warmer quickly warms and maintains the temperature of injection/intravenous and irrigation solutions prior to their use. The specially contoured warming module cradles solution bags in 0.5, 1, 2, and 3-liter sizes. ivNow® units can be customized in the field by stacking or removing pods from the configuration. Units can be used for countertop use, wall mounted with the provided mounting plate, or equipment pole stand.

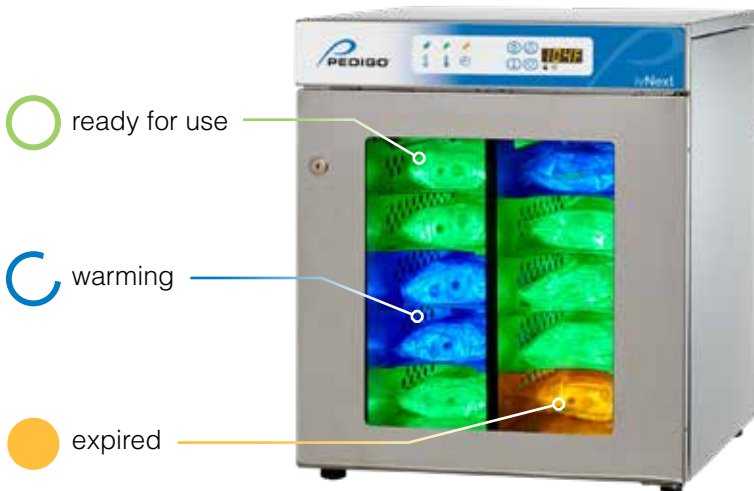

WarmSafe™ Technology

ivNext®

P-2300



ivNext®

Intelligent fluid warming and IV inventory staging system.

- Know when an IV bag has reached the recommended set point temperature (adjustable injection mode)
- Color-coded lighting indicates bag readiness or expiration.
- Organized inventory allows for faster retrieval of fluids.
- Overall Size:** 18½"W x 22"D x 22"H
- Capacity:** 2.5 cubic ft. | 10 1-liter bags



mayo stands

foot-pedal operated

- Base designed to move under low clearance equipment with maximum stability
- Convenient foot-pedal operated lock adjusts height from 36" to 62"
- **co•re casters™** corrosion-resistant, maintenance-free
- All welded stainless steel construction



P-1065-SS

- Removable extra large 20" x 25" stainless steel tray for easy cleaning
- Two 2" corrosion-resistant Gemini **co•re casters™**
- 50 lbs. weight capacity evenly distributed



P-1066-SS

- Removable 16 $\frac{1}{4}$ " x 21 $\frac{1}{4}$ " stainless steel tray for easy cleaning
- Two 2" corrosion-resistant Gemini **co•re casters™**
- 50 lbs. weight capacity evenly distributed



P-1068-SS

- Removable 12 $\frac{5}{8}$ " x 19 $\frac{1}{8}$ " stainless steel tray for easy cleaning
- Two 2" corrosion-resistant Gemini **co•re casters™**
- 50 lbs. weight capacity evenly distributed



P-1069-SS

- Removable large 16 $\frac{1}{4}$ " x 21 $\frac{1}{4}$ " stainless steel tray for easy cleaning
- Four 2" corrosion-resistant Gemini **co•re casters™**
- 50 lbs. weight capacity evenly distributed



P-1066-A-SS

- Removable 16 $\frac{1}{4}$ " x 21 $\frac{1}{4}$ " stainless steel tray for easy cleaning
- Adjust height 36" to 60" - friction lock
- Two 2" corrosion-resistant Gemini **co•re casters**[™]
- 50 lbs. weight capacity evenly distributed



P-1068-A-SS

- Removable 12 $\frac{5}{8}$ " x 19 $\frac{1}{8}$ " stainless steel tray for easy cleaning
- Adjust height 36" to 60" - friction lock
- Two 2" corrosion-resistant Gemini **co•re casters**[™]
- 50 lbs. weight capacity evenly distributed

mayo stands

hand operated

- Base designed to move under low clearance equipment with maximum stability
- **co•re casters**[™] corrosion-resistant, maintenance-free
- All welded stainless steel construction



P-1069-A-SS

- Removable large 16 $\frac{1}{4}$ " x 21 $\frac{1}{4}$ " stainless steel tray for easy cleaning
- Adjust height 36" to 60" - friction lock
- Four 2" corrosion-resistant Gemini **co•re casters**[™]
- 50 lbs. weight capacity evenly distributed



P-66

- Removable 19 $\frac{1}{8}$ "L x 12 $\frac{5}{8}$ "W stainless steel tray on powder-coated frame
- Adjust height from 32" to 53" - friction lock
- Two 3" corrosion-resistant **co•re casters**[™]
- 20 lbs. weight capacity evenly distributed



P-65 Medical Tray Unit

- Removable 19 $\frac{1}{8}$ "L x 12 $\frac{5}{8}$ "W stainless steel tray on chrome plated base
- Swivel height adjust from 30" to 40"
- Four 3" corrosion-resistant **co•re casters**[™]
- 40 lbs. weight capacity evenly distributed



new!

**co•re
caster™**

basin stands

features

- Open frame design allows access from all sides
- **co•re casters™** corrosion-resistant, maintenance-free
- Elevated ring basin bracket
- Mobile and easy to clean



P-78

- Single basin stand
- Near chrome powder coat finish
- 13¾"D x 14"W x 33¾"H
- One removable 13½" diameter, 7 quart stainless steel basin
- Steel construction

P-1078-SS

- Single basin stand
- Stainless steel
- 13¾"D x 14"W x 33¾"H



P-1078-W/S-SS

- Single basin stand with shelf
- Stainless steel
- 13¾"D x 14"W x 33¾"H
- One removable 13½" diameter, 7 quart stainless steel basin
- Stainless steel construction

P-1079-W/S-SS

- Double basin stand with shelf
- Stainless steel
- 14"D x 28"W x 33¾"H



P-79

- Double basin stand
- Near chrome powder coat finish
- 13¾"D x 28"W x 33¾"H
- Two removable 13½" diameter, 7 quart stainless steel basins
- Steel construction

P-1079-SS

- Double basin stand
- Stainless steel
- 14"D x 28"W x 33¾"H



P-1020-SS

kick bucket

- Stainless steel

Overall size

13¾" diameter x 13¼"H

- Removable 12 quart, stainless steel bucket

kick buckets

features

- Balanced, tip-resistant
- Perimeter bumper to protect walls
- Electro-polished, stainless steel frame
- 2" diameter double ball bearing swivel casters for easy mobility



P-1025-SS

sponge receptacle

- Stainless steel

Overall size

16½" diameter x 7½"H

- Removable 8½ quart, stainless steel basin

new!

P-1130-L-SS

Dimensions

17³/₈"D x 18"W x 31"H

- Stainless Steel
- Quiet-Close™ lid dampener
- 3" **co•re casters**™
- Foot operated
- Accommodates 18" bags



P-1130-SS

Dimensions

14"D x 16"W x 30³/₄"H

- Stainless Steel
- No lid
- 3" **co•re casters**™
- Accommodates 18" bags

new!
**co•re
caster**™

hampers

Pedigo's newly designed lidded hampers feature the **Quiet-Close™** lid dampener for improved safety and added control of airborne bacteria and odors.

Linen hampers are constructed of heavy gauge steel and feature double ball bearing, 3" corrosion-resistant **co•re casters**™ for easy mobility.



Quiet-Close™ lid dampener



P-120-L and P-121-L

P-120-L

Dimensions

32"H with a 59¹/₂" perimeter

- Powder coated steel
- Foot operated
- Accommodates 18" bags

P-121-L

Dimensions

35"H with a 80⁷/₈" perimeter

- Powder coated steel
- Foot operated
- Accommodates 25" bags



P-1120-L-SS and P-1121-L-SS

P-1120-L-SS

Dimensions

32"H with a 59¹/₂" perimeter

- Stainless steel
- Foot operated
- Includes rolling bumpers
- Accommodates 18" bags

P-1121-L-SS

Dimensions

35"H with a 80⁷/₈" perimeter

- Stainless steel
- Foot operated
- Includes rolling bumpers
- Accommodates 25" bags



P-120 and P-121

P-120

Dimensions

32"H with a 59¹/₂" perimeter

- Powder coated steel
- Accommodates 18" bags
- * 30" under counter hamper available

P-121

Dimensions

35"H with a 80⁷/₈" perimeter

- Powder coated steel
- Accommodates 25" bags



P-1120-SS and P-1121-SS

P-1120-SS

Dimensions

32"H with a 59¹/₂" perimeter

- Stainless steel
- Includes rolling bumpers
- Accommodates 18" bags

P-1121-SS

Dimensions

35"H with a 80⁷/₈" perimeter

- Stainless steel
- Accommodates 25" bags

P-1015-TC

Dimensions

28"D x 14¾"W x 40¼"H

- Stainless Steel
- Holds up to six P-1015
- 3" Genesis diameter swivel casters
- Genesis casters are maintenance-free (#62-B)



P-1015

footstools

features

- Strong, all welded steel
- Legs and handrail constructed of 1" O.D. 16-gauge tubular steel
- Corrugated, black rubber top surface
- Rubber floor tips

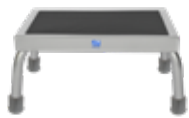

P-10

Powder Coat

12"D x 16"W x 8"H

300 lbs. weight capacity



P-10-A

Powder Coat

12"D x 16"W x 8"H

300 lbs. weight capacity

- 39"H with handrail



P-1010-A-SS

Stainless Steel

12"D x 16"W x 8"H

300 lbs. weight capacity

- 39"H with handrail



P-1010-SS

Stainless Steel

12"D x 16"W x 8"H

300 lbs. weight capacity



P-18

Powder Coat

12"D x 16"W x 16¼"H

300 lbs. weight capacity

- First step 9"H
- Second step 16¼"H



P-18-A

Powder Coat

12"D x 16"W x 16¼"H

300 lbs. weight capacity

- First step 9"H
- Second step 16¼"H
- 47"H with handrail



P-11

Powder Coat

12"D x 30"W x 8"H

300 lbs. weight capacity



P-1011-SS

Stainless Steel

12"D x 30"W x 5"H

300 lbs. weight capacity



P-1012-SS

Stainless Steel

12"D x 30"W x 8"H

300 lbs. weight capacity



P-1015

Stainless Steel

14"D x 19"W x 6¼"H

650 lbs. weight capacity

- Interlock footstools to create larger platforms
- Heavy gauge legs and handles

Safely stack for increased height

P-1572-4 four hook

- Hand operated, friction lock height adjustment
- Height adjustable from 68½" to 117½"
- Five leg base
- 70 lbs. overall weight capacity
- 10 lbs. per hook (recommended 30 lbs. max. evenly distributed on top hooks for stability)

Safe Load Capacity

For stability, a safe load on this series I.V. pole should not exceed 40 lbs. to one side and needs to be within 6" of base tube center line.

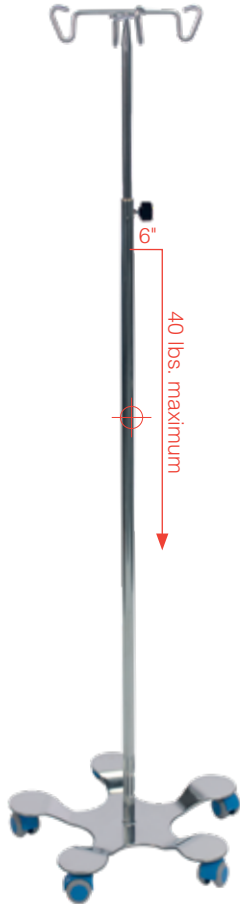

iv stands

features

- Stainless steel
- Heavy, tip-resistant, all welded design
- 2" swivel dual-wheel casters for easy
- 21¼" diameter base on all stands mobility
- Tube: O.D. = 1"
- Easy to clean surfaces

clearview technology™

- For the easy reading of all IV bag labels from the front of the stand.
- Hooks are ideal for IV piggybacking of primary and secondary bags.

clearview technology™



P-1572-CV six hook

- Hand operated, friction lock height adjustment
- Height adjustable from 69½" to 119"
- Five leg base
- 70 lbs. overall weight capacity
- 7 lbs. per hook (recommended 30 lbs. max. evenly distributed on top hooks for stability)

P-1576-4 four hook

- Quick and easy one-hand foot pedal height adjustment
- Height adjustable from 68½" to 117½"
- 70 lbs. overall weight capacity
- 10 lbs. per hook (recommended 30 lbs. max. evenly distributed on top hooks for stability)

clearview technology™

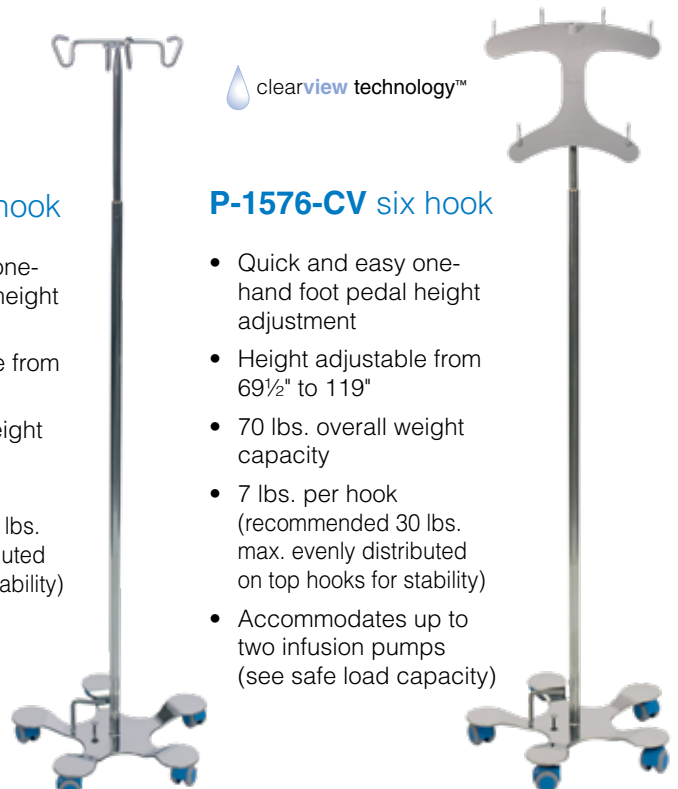

P-1576-CV six hook

- Quick and easy one-hand foot pedal height adjustment
- Height adjustable from 69½" to 119"
- 70 lbs. overall weight capacity
- 7 lbs. per hook (recommended 30 lbs. max. evenly distributed on top hooks for stability)
- Accommodates up to two infusion pumps (see safe load capacity)

new!



P-1095-8 eight hook

- Hand operated, friction lock height adjustment
- Height adjustable from 70" to 120"
- Five leg base
- 95 lbs. overall weight capacity
- 10 lbs. per hook (recommended 30 lbs. max. evenly distributed on top hooks for stability)

Safe Load Capacity

For stability, a safe load on this series stand should not exceed 75 lbs. within 6" off center.

- 95 lbs max total pumps and bags.

Weight Capacity
75 lbs. 6" off center

infusion pump stand

features

- Bag Drop Prevention Device allows for controlled descent of pole.
- Stainless steel IV hook assembly features eight hooks.
- Heavy duty 3" sealed casters with precision ball bearings.
- Powder-coated 30 lbs. steel base.
- Pole sleeve welded securely to the base for reinforced stability.



infusion pump stand



Option - Handle & Tray Insert



Heavy-Duty 30 lbs. Base
26" Diameter



Offset Post

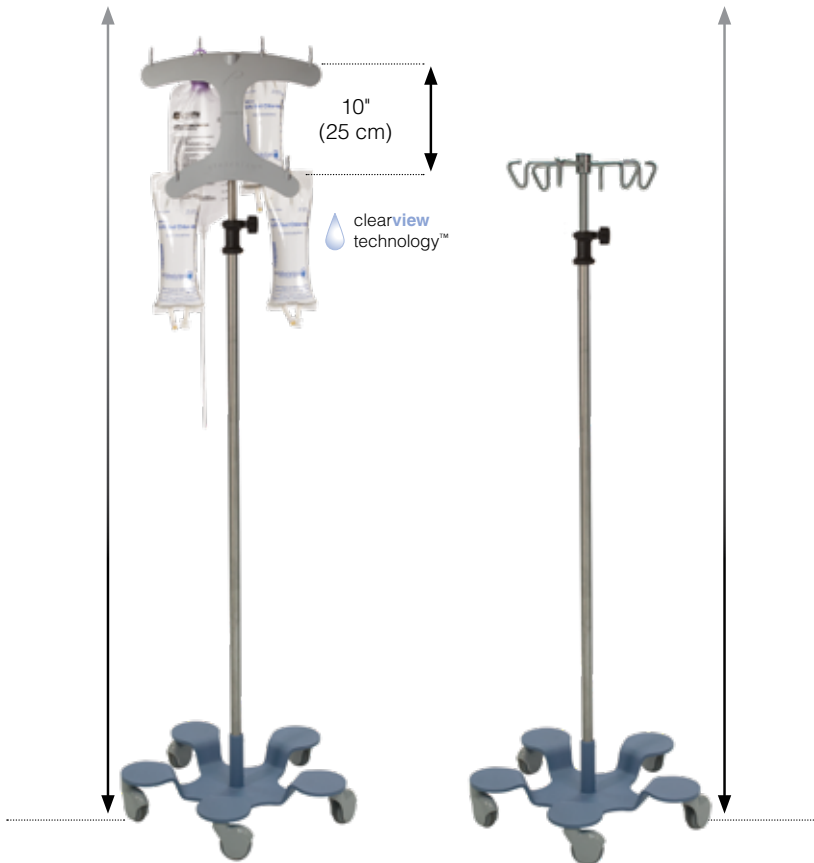

P-1080-CV
Height adjustable
from 71" to 124"

P-1080-6
Height adjustable
from 72½" to 124"



P-1083-CV
Height adjustable
from 71" to 124"

P-1083-6
Height adjustable
from 72½" to 124"

infusion pump stand

common features

- Bag Drop Prevention Device allows for controlled descent of pole.
- Heavy duty 3" (8cm) sealed casters with precision ball bearings.
- Extremely durable powder coat finish base.
- Low center of gravity design and 27 lbs. base offers improved stability
- Pole sleeve welded securely to the base for reinforced stability.
- Small 23" (58cm) base reduces stumbles and falls while patient ambulates.
- Hand operated easygrip™ knob.

P-1080-CV

- High impact molded polymer IV hook assembly features six hooks.

P-1080-6

- Six stainless steel IV hooks

P-1083-CV

- High impact molded polymer IV hook assembly features six hooks.
- Pole made from copper nickel alloy.

P-1083-6

- Pole made from copper nickel alloy.
- Six stainless steel IV hooks



Pole

Stainless steel resists staining, corrosion and rusting.

Stainless Steel Base

Low center of gravity design and 27 lbs. base offers improved stability.

23" Diameter Base

Small base reduces stumbles and falls while patient ambulates.

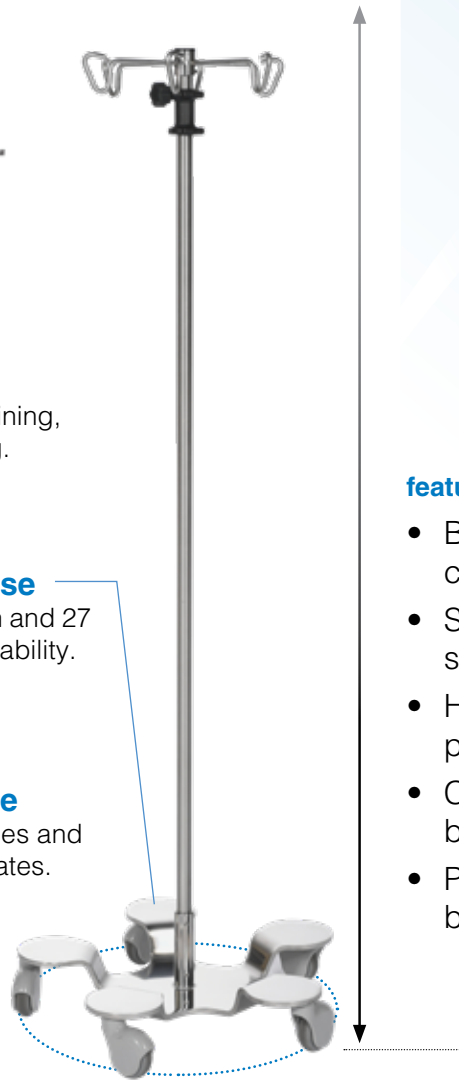

Height adjustable from 70½" to 124"

P-1080-SS

infusion pump stand

features

- Bag Drop Prevention Device allows for controlled descent of pole.
- Stainless steel IV hook assembly features six hooks.
- Heavy duty 3" (8cm) sealed casters with precision ball bearings.
- Corrosion resistant all stainless steel base.
- Pole sleeve welded securely to the base for reinforced stability.



Stainless base

infusion pump accessories



PATIENT HANDLE

Adjustable handle provides easy mobility.

- P-3305 Stainless Steel
- P-3306 Copper nickel alloy
- P-3307 Black
- P-3305-T Tray Insert



CV HOOK

Molded polymer six hook IV assembly

- P-1090-CV-TH Assembly

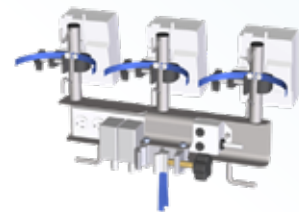

INFUSION PUMP HOLDER

Holds up to 3 pumps

- P-1080-G Infusion Pump Holder



8-HOOK ASSEMBLY

Extended IV Hook Assembly

- P-1080-H Stainless Steel



IV SET ORGANIZER

Also holds secondary bags

- P-1080-B Stainless Steel



S'MORE HOOK

For mounting additional IV bags

- P-1080-J Stainless Steel



WIRE BASKET

- P-3201 Large (Stainless)
- P-3202 Large (Black)
- P-3211 Med (Stainless)
- P-3212 Med Black



FOLEY HOOK

- P-1080-D Foley 2 Hooks
- P-1080-E Foley 1 Hook
(Factory installed)



O₂ HOLDER

Holds E-size oxygen tanks

- P-3601 Stainless Steel

infusion pump accessories



P-230X-MK
Pole Mount Kit



IVNOW POLE MOUNT KIT

ivNow1, ivNow2 & ivNow3
P-230X-MK Pole Mount Kit

Kit includes:

- Two Clamps & Hardware

Recommended stands:

- P-1080, P-1083 & P-1095



OUTLET STRIP

Hospital grade
P-3401 Six outlet strip

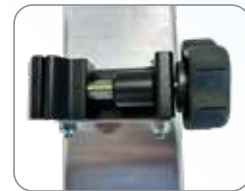

RPT SECURITY SLEEVE

Power strip & security sleeve
P-3401-TR Tamper-Resistant RPT



INFUSION PUMP HOOP

Holds up to 6 pumps

P-1080-F Stainless Steel
P-1083-F Copper nickel alloy



MULTIPLE PUMP HOLDER

Infusion pump holder

P-1080-C Stainless Steel
P-1083-C Copper nickel alloy





features

Pedigo's new IV stand features a number of unique design elements to further promote safety, organization and efficiency of IV fluid administration.

 **clearview technology™**
High impact molded polymer IV hook assembly features six hooks for easy reading all IV bag labels from the front of the stand.
Built-in offset for IV piggybacking.
Smooth finish and easy to clean.

 **clearstep technology™**
Created with patient and staff safety in mind, the element's clearstep base is ergonomically designed for easy ambulation.

 **interlockingbases™**
The interlockingbases™ allow for multiple stands to be moved at one time by connecting the element™ together.
Designed for comfortable transport and storage of multiple stands.





Adjustment

Hand operated easygrip™ knob.

Pole

Stainless steel resists staining, corrosion and rusting.

Base

Five caster, 19 lbs. (9 kg) base offers improved stability.

Casters

Precision ball bearing sealed casters for ultra low rolling resistance.

Footprint - 21.25 (54 cm)

Small footprint allows unobstructed path while patient ambulates.

P-1090-CV Infusion Pump Stand

SPECIFICATIONS

element™		P-1090-CV
Weight		
Overall Product Weight		26 lbs. (12 kg)
Base Weight (with Casters)		19 lbs. (9 kg)
Weight Capacity (Maximum)		
Hooks (each)		7 lbs. (3 kg)
Offset Load (Base Tube)†		40 lbs. (18 kg)
Total Load‡		90 lbs. (41 kg)
Number of Pumps per Stand		4 (10 lbs. each)
Casters		
5 Swivel Casters		3" (8 cm)
Height Adjustment		
Low		74" (188 cm)
High		122" (310 cm)
Base Diameter (Caster Centerline)		
		21.25" (54 cm)
Number of Interlocking Stands (Max.)		
6		
Accessories		
Patient Handle	O ₂ Holder	Basket
Outlet Strip	Foley bag Hook	

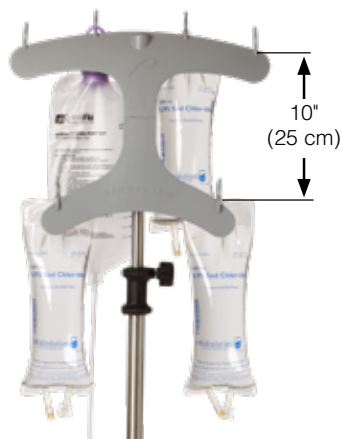

The clearview™ hooks are ideal for IV piggybacking of primary and secondary bags with a full 10" of height difference between bags.

† 40 lbs max applied at 6" off center, 3 ft off ground
 ‡ 90 lbs max applied at centerline of pole, 3 ft off ground

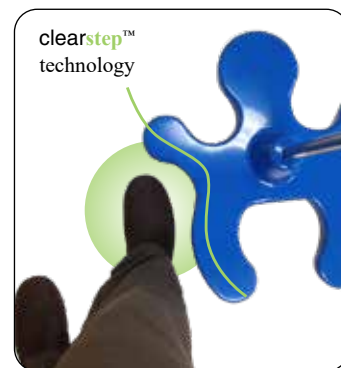

With a recess on each side of the base, emulating the natural shape of the foot, clearstep™ allows for safe ambulation.



space station

two tier back table

A specialty back table designed with additional room for large cases such as orthopedics, spinal fusions, neuro and craniotomies. The tuck-away cantilevered shelf holds multiple trays and is angled for clear observation of instruments.

The Space Station is easily rolled into position using 4" diameter, heavy-duty ball bearing brake/swivel casters. To lock swivel caster, simply engage the single-pedal brake.

CDS-3060 Dimensions
Main Table 30"D x 60"W x 34"H
Top Shelf 20"D x 60"W



CDS-3072 Dimensions
Main Table 30"D x 72"W x 34"H
Top Shelf 20"D x 72"W

One Person Operation



Pneumatic assist enables one-person operation in raising or lowering the cantilevered shelf.



Shelf is easily raised when extra space is required, or lowered into storage position if not needed.

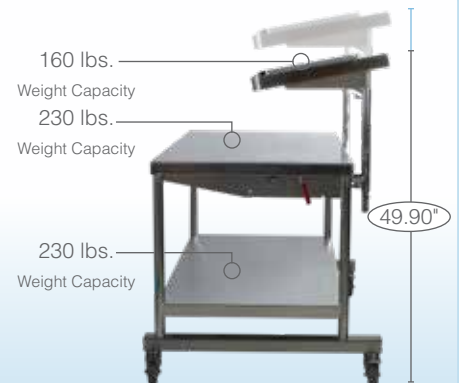

Cantilevered shelf features a 10° slope and has an adjustable height from 49.9" to 52.9".

trusted fit **drapes**
two-tier

Disposable Table Drapes

Pedigo Trusted Fit drapes feature heavy-duty three layer construction. 12 Drapes per case.

CDS-3060-DD 5' table (1.5m)

CDS-3072-DD 6' table (1.8m)

100% u.s.a. supply chain

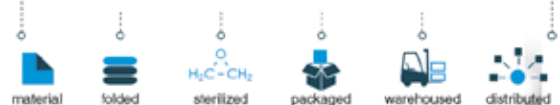



Elevate & Illuminate Table
 CDS-3060-ADJ-E5' table (1.5m)
 CDS-3072-ADJ-E6' table(1.8m)
 Illuminate Table
 CDS-3060-L.....5' table (1.5m)
 CDS-3072-L.....6' table(1.8m)

space station

electric adjustable back table

Pedigo's **NEW** Space Station back table is now electro-hydraulically height adjustable and LED illuminated for improved visibility.

efficiency • ergonomic • safety

For patient and staff safety, the Space Station Two-Tier Back Table meets the highest hospital safety standards. IEC 60601-1 and UL approved E 503 186 approved.



Height Adjustment

The UP/DOWN buttons for height control are located to the left of the power supply.

Power Cord

Hospital grade power cord can be wound around cord loops when not in use. Cord length measures 9' 8" (3m).

Latch Release

Pull up on the release latch to disengage and lower upper tier. Release Latches are located on either side of the table.



Casters

The Electric Adjustable Space Station features four Total Lock Casters each measuring 4" (10cm) in diameter.



Power Supply

At the back of the table are two independent ON/OFF toggle switches to control the entire table unit and a second for the LED lights.



draping
Space Station
 video demo

draping video demo online
www.pedigo-usa.com

new!



Elevate & Illuminate Table

CDS-3060-ADJ-E ... 5' table (1.5m)
CDS-3072-ADJ-E ... 6' table(1.8m)

Illuminate Table

CDS-3060-L 5' table (1.5m)
CDS-3072-L 6' table(1.8m)



space station

electric adjustable back table

Pedigo's **NEW** Space Station back table is now electro-hydraulically height adjustable and LED illuminated for improved visibility.

efficiency • ergonomic • safety

For patient and staff safety, the Space Station Two-Tier Back Table meets the highest hospital safety standards. IEC 60601-1 and UL approved E 503 186 approved.



Upper tier in storage position



Upper tier being raised



Upper tier in raised position

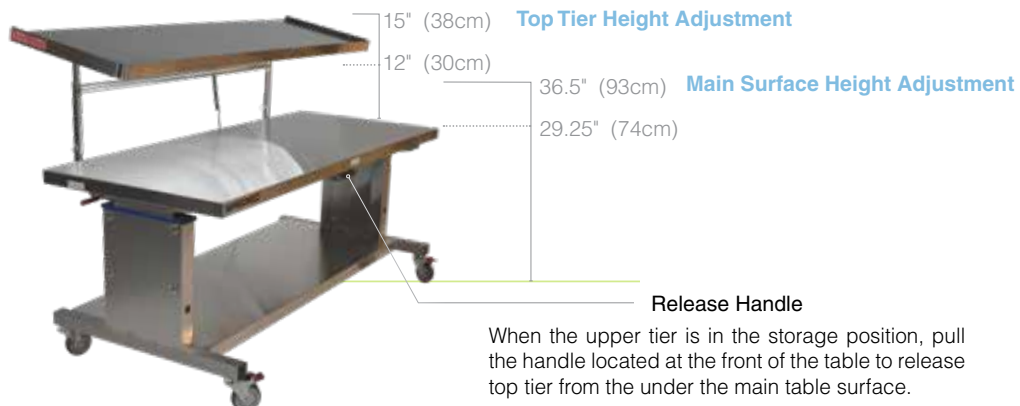



CDS-1100

Main Table Top Surface
72"W x 30"D

Height Adjustable
32" to 43¼"H

instrument assembly station table

features

- Electrically operated hydraulic height adjustment provides comfortable, ergonomic height settings for all staff members.
- Shelves are positioned 18" and 30" above main work surface, and measure 72"W x 12"D with 5/8" front lip.
- Shelves also feature a 10° slope.
- Load capacity of 225 pounds on main work surface and 50 pounds on each upper shelf.
- 4" zinc plated steel brake/swivel lock casters with precision ball bearings for easy mobility.

accessories

1 Work Lamp CDS-1020

- Work Lamp arm has a 42" reach
- Features a 5" viewing lens
- 75% magnification

2 Outlet Strip CDS-1015

- Hospital grade
- Six outlets
- 15' foot cord

3 Keyboard Tray CDS-1032

- Measures 22¼"W x 10"D x 2¾"H
- Tray extends 10½" (retractable)
- Built-in mouse tray comes standard

4 Computer Enclosure CDS-1031

- Open back for air flow and easy access to computer cords.
- Enclosure can be customized to accommodate larger computer towers (max. load 30 lbs/13.60 kg)

5 Extension Arm CDS-1030

- Supports LCD monitors (max. load 25 lbs / 11.3 kg)
- For optimal viewing, extension arm features multi-directional adjustment
- Gas-strut and ball-joint system for smooth, stable operation

6 Storage Cart CDS-1010

- 4 drawer tote box cart for added storage fits under the workstation
- Totes are constructed of impact-resistant, high-density polyethylene and measure 17¾"L x 14½"W x 5"D



SG-82-SS

new!
**co•re
caster™**

instrument tables

features

- Stainless steel Steril-Gard construction eliminates full sub-tops where undesirable substances can collect
- Easy to clean
- Lightweight but strong
- 3" double ball bearing, corrosion-resistant **co•re casters™**
- Sound-deadened reinforcing channels for quiet use*

* feature not present on model SG-82-SS

Mid-Size Tables with Shelf

Dimensions

SG-82-SS	20"W x 16"D x 34"H
SG-84-SS	30"W x 16"D x 34"H
SG-86-SS	33"W x 18"D x 34"H
SG-88-SS	36"W x 20"D x 34"H



SG-87-SS



SG-92-SS



SG-93-SS

Mid-Size Tables without Shelf

Dimensions

SG-83-SS	20"W x 16"D x 34"H
SG-85-SS	30"W x 16"D x 34"H
SG-87-SS	33"W x 18"D x 34"H
SG-89-SS	36"W x 20"D x 34"H

Large Tables with Shelf

Dimensions

SG-90-SS	48"W x 20"D x 34"H
SG-92-SS	48"W x 24"D x 34"H
SG-94-SS	60"W x 24"D x 34"H
SG-96-SS	72"W x 24"D x 34"H
SG-98-SS	36"W x 24"D x 34"H

Large Tables without Shelf

Dimensions

SG-91-SS	48"W x 20"D x 34"H
SG-93-SS	48"W x 24"D x 34"H
SG-95-SS	60"W x 24"D x 34"H
SG-97-SS	72"W x 24"D x 34"H
SG-99-SS	36"W x 24"D x 34"H

options

- 3 or 4 sided top and shelf rails available for all tables.
- Stainless steel drawers, or tote boxes may be mounted under top.
- Table height can be modified

Tote Boxes

Impact-resistant, high-density polyethylene.

- CDS-TB-5" (17¾"L x 14½"W x 5⅛"D)
- CDS-TB-10" (17¾"L x 14½"W x 10"D)

Tote Box Hangers

- SG-TBH-1 16"D SG Tables
- SG-TBH-2 18"D SG Tables
- SG-TBH-3 20"D SG Tables
- SG-TBH-4 24"D SG Tables

Glides/ Rubber Feet/ Casters

- #15 Glides
- #13 Rubber Feet
- #06 Locking Casters

IV Pole for SG Tables

- P-7202-1 available on lower shelf models only.



SG-80-SS

table with shelf, drawer and rail

overall size
20"W x 16"D x 34"H

drawer size
15¼"W x 12½"L x 3"H (I.D.)



utility
tables

features

- Convenient and easy to use
- Stainless steel, Steril-Gard construction eliminates full sub-tops
- Improves the control of undesirable substances
- Full extending drawer hangers (except SG-81-SS)
- Sound-proofed reinforcing channels for quiet use and added strength
- 3" double ball bearing, rubber casters for silent mobility
- 1½" high 3-sided top rail

options

- Part No. 46-B Drawer lock with key
- Part No. 06 3" casters with brakes



SG-80-A-SS

table with shelf, two drawers and rail

overall size
20"W x 16"D x 34"H

drawer size (I.D.)
15¼"W x 12½"L x 3"H



SG-80-B-SS

table with shelf and drawer

overall size
20"W x 16"D x 34"H

drawer size (I.D.)
15¼"W x 12½"D x 3"H



SG-80-C-SS

table with shelf and two drawers

overall size
20"W x 16"D x 34"H

drawer size (I.D.)
15¼"W x 12½"D x 3"H



SG-81-SS

table with shelf and rail

overall size
20"W x 16"D x 34"H



SG-82-SS

table with shelf

overall size
20"W x 16"D x 34"H



shown with optional accessories

CDS-2472

overall size: 72"W x 24"D x 34"H

optional accessories

- 4" swivel casters with brakes
- Full length lower shelf
- Tote box drawers: 5" or 10" deep
- Stainless steel drawers: 15½"W x 12½"D x 3½"H (installed, complete)



Caster with brake

central supply tables

features

- Heavy duty, all stainless steel construction
- Height adjustable floor glides
- For use in areas where a table larger than a standard utility or work table is needed



shown with optional accessories

CDS-3260

Overall size: 60"W x 32"D x 34"H

optional accessories

- 4" swivel casters with brakes
- Full length lower shelf
- Sterile Wrap frame: 56"W x 30½"H
- Tote box drawers: 5" or 10" deep
- Stainless steel drawers: 15½"W x 12½"D x 3½"H (installed, complete)



Caster with brake



shown with optional accessories

CDS-3684

Overall size: 84"W x 36"D x 34"H

optional accessories

- 4" swivel casters with brakes
- Full length lower shelf
- Tote box drawers: 5" or 10" deep
- Stainless steel drawers: 15½"W x 12½"D x 3½"H (installed, complete)



Caster with brake



over-operating table

P-5182 Dimensions

Standard Top 34"W x 42"D

Pedigo's Over-Operating Specialty Table is constructed of stainless steel and features easy, one-hand height adjustment.

- 3" total lock casters, with brakes and swivel locks
- Adjustable height from 37¹/₄" to 52¹/₄" high from floor
- 27³/₄" clearance between legs
- Other sizes available upon request.

Part Number	Description	Dimension			
P-5182-3	Base ONLY (Standard)	28" ID Clearance			
P-5182-34	Base ONLY (Wide)	34" ID Clearance			
P-5182-36	Base ONLY (X-Wide)	36" ID Clearance			
			Base (P-5182-3)	Base (P-5182-34)	Base (P-5182-36)
P-5182-2	Top ONLY (Standard)	34"W x 42"D	•		
P-5182-3420	Top ONLY	34"W x 20"D	•		
P-5182-3424	Top ONLY	34"W x 24"D	•		
P-5182-3430	Top ONLY	34"W x 30"D	•		
P-5182-3436	Top ONLY	34"W x 36"D	•		
P-5182-3448	Top ONLY	34"W x 48"D	•		
P-5182-3820	Top ONLY	38"W x 20"D	•		
P-5182-3824	Top ONLY	38"W x 24"D	•		
P-5182-3830	Top ONLY	38"W x 30"D	•		
P-5182-3836	Top ONLY	38"W x 36"D	•		
P-5182-3842	Top ONLY	38"W x 42"D	•		
P-5182-3848	Top ONLY	38"W x 48"D	•		
P-5182-4220	Top ONLY	42"W x 20"D	•	•	•
P-5182-4224	Top ONLY	42"W x 24"D	•	•	•
P-5182-4230	Top ONLY	42"W x 30"D	•	•	•
P-5182-4236	Top ONLY	42"W x 36"D	•	•	•
P-5182-4242	Top ONLY	42"W x 42"D	•	•	•
P-5182-4248	Top ONLY	42"W x 48"D	•	•	•
P-5182-4620	Top ONLY	46"W x 20"D	•	•	•
P-5182-4624	Top ONLY	46"W x 24"D	•	•	•
P-5182-4630	Top ONLY	46"W x 30"D	•	•	•
P-5182-4636	Top ONLY	46"W x 36"D	•	•	•
P-5182-4642	Top ONLY	46"W x 42"D	•	•	•
P-5182-4648	Top ONLY	46"W x 48"D	•	•	•





seating

five series

● **P-521-GS** ● **T-521-GS** ● **P-526-GS** ● **T-526-GS**

- 14½" round fully padded seat with back
- 23½" diameter aluminum base
- 2" dual wheel casters
- Height adjustment (pneumatic) of 19¼" to 23¾"
- Adjustable backrest

features

- weight capacity rating of 300 lbs.

upholstery

- classic ●
- royal ●

dual wheel locking casters option

- 66 Locking Casters (activated upon standing)
- 66-A Locking Casters (activated upon sitting)



● **P-536** ● **T-536** ● **P-536-GS** ● **T-536-GS** ● **P-551-GS** ● **T-551-GS** ● **P-555-GS** ● **T-555-GS**

- 14" cushioned seat
 - 21½" diameter chrome base
 - 3" **co-re casters™**
 - Height adjustment (screw shaft) of 17¾" to 26⅞"
- 14" cushioned seat
 - 21½" diameter chrome base
 - 3" **co-re casters™**
 - Height adjustment (pneumatic) of 18¾" to 23½"
- 16" x 17" cushioned seat
 - 21½" diameter chrome base
 - Adjustable back support
 - 3" **co-re casters™**
 - Height adjustment (pneumatic) of 19¼" to 24" height
 - Adjustable backrest
- 16" x 17" cushioned seat
 - 21½" diameter chrome base
 - Adjustable back support
 - 3" **co-re casters™**
 - Height adjustment (pneumatic) of 25⅝" to 33"
 - Adjustable backrest

* locking casters option not available * locking casters option not available * locking casters option not available * locking casters option not available



P-1037-SS

- 14" round stainless steel contoured seat
- Rubber floor tips
- Height adjustment (screw shaft) of 20¹/₈" to 32³/₈"

P-1037-W/C-SS

- 3" **co•re casters™**
- Height adjustment (screw shaft) of 22¹/₂" to 34⁵/₈"



• P-1038-SS • T-1038-SS

- 14" round cushioned seat
- Rubber floor tips
- Height adjustment (screw shaft) of 22" to 34¹/₂"

• P-1038-W/C • T-1038-W/C

- 3" **co•re casters™**
- Height adjustment (screw shaft) of 24¹/₄" to 36³/₄"

seating

stainless steel series

features

- weight capacity rating of 300 lbs.
- Available in Classic

upholstery

- classic ●
- royal ●

dual wheel locking casters option

- 66 Locking Casters (activated upon standing)
- 01-B Adaptor (required for 66)



• **P-527-GS** • **T-527-GS**

- 14½" round fully padded seat
- 23½" diameter aluminum base
- 2" dual wheel casters
- Adjustable backrest
- Height adjustment of 19¼" to 24½" (pneumatic)

seating

foot-operated

features

- weight capacity rating of 300 lbs.

upholstery

- classic ●
- royal ●

locking casters option

- 66 Locking Casters (activated upon standing)
- 66-A Locking Casters (activated upon sitting)



• **P-528-GS** • **T-528-GS**

- 14½" round fully padded seat
- 23½" diameter aluminum base
- 2" dual wheel casters
- Height adjustment of 19¼" to 24½" (pneumatic)



- **P-36** • **T-36**
- 14" round cushioned seat
- 3" **co•re casters™**
- Height adjustment (screw shaft) of 17⁷/₈" to 26¹/₄"



seating

powder-coat series

features

- weight capacity rating of 300 lbs.

upholstery

- classic ●
- royal ●

dual wheel locking casters option

- 66 Locking Casters (activated upon standing)
- 01-B Adaptor (required for 66)



- **P-38** • **T-38**
- 14" round cushioned seat
- Rubber floor tips
- Height adjustment (screw shaft) of 22" to 34¹/₂"

- **P-38-W/C** • **T-38-W/C**
- 3" **co•re casters™**
- Height adjustment (screw shaft) of 24¹/₄" to 36³/₄"



● T-580

- 18" x 19" contoured cushioned seat
- Height adjustment (pneumatic) of 17½" to 23¼"
- Easy rolling 2" dual wheel casters
- 25" diameter footprint
- Adjustable backrest
- Adjustable arm rests



● T-581

- 18" x 19" contoured cushioned seat
- Height adjustment (pneumatic) of 17½" to 23¼"
- Easy rolling 2" dual wheel casters
- 25" diameter footprint
- Adjustable backrest



● T-582

- 18" x 19" contoured cushioned seat
- Height adjustment (pneumatic) of 17½" to 23¼"
- Easy rolling 2" dual wheel casters
- 23" diameter footprint (small)
- Adjustable backrest

seating

ergo task chair

features

Pedigo's ergonomically designed task chairs feature pneumatic height adjustment, dual wheel casters, 5-star base, integrated lumbar support, and independent backrest/seat pan height and tilt controls. PVC and latex free.

- weight capacity rating of 300 lbs.

upholstery

- only available in royal ●

locking casters option

- 81 Locking Casters (activated upon standing)



T-583

- 18" x 19" contoured cushioned seat
- Height adjustment (pneumatic) of 24¼" to 34¼"
- Easy rolling 2" dual wheel casters
- 25" diameter footprint
- Adjustable backrest
- Adjustable arm rests

T-584

- 18" x 19" contoured cushioned seat
- Height adjustment (pneumatic) of 23½" to 33½"
- Easy rolling 2" dual wheel casters
- 25" diameter footprint
- Adjustable backrest



specs



seating

ergo task anesthesia chair

features

Ergonomically designed anesthesia chair, Pedigo's T-583 features pneumatic height adjustment, dual wheel casters, 5-star base, integrated lumbar support and independent backrest/seat pan height tilt controls. PVC and latex free.

- weight capacity rating of 300 lbs.

upholstery

- only available in royal ●

locking casters option

- 81 Locking Casters (activated upon standing)



Locking Casters

●● **P-7000**

- Specially contoured seat for added comfort
- Sensafoam body contouring seat and back
- Seat features backrest
- Height adjustable and articulating arm/wrist rests
- 21" diameter base with high grade 3" casters
- 5-caster base
- Three locking casters
- Adjustable backrest
- Height adjustment (hydraulic) of 20³/₄" to 28¹/₄" - single pedal, foot-operated



●● **P-6000** with Backrest

- 16" round fully padded
- Seat features backrest
- 21" diameter base
- Powder-coated 5-caster base
- High grade 3" casters
- Three locking casters
- Height adjustment (hydraulic) of 22³/₄" to 30¹/₄" - single pedal, foot-operated



●● **P-6001** without Backrest

- 16" round fully padded
- No backrest
- 21" diameter base
- Powder-coated 5-caster base
- High grade 3" casters
- Three locking casters
- Height adjustment (hydraulic) of 22³/₄" to 30¹/₄" - single pedal, foot-operated



features

Hydraulic Surgeon Chairs are ideal for surgery, anesthesiology, ENT and reconstructive procedures.

- weight capacity rating of 300 lbs.

upholstery

- Available in classic and royal.

option (P-6000)

- articulating arm rests #P-6000-D.



* Seat tilt not available with procedure rest



●● **P-6000-PR** Procedure Rest

- Rotates a full 360 degrees
- Upholstered for comfort
- Special density foam provides comfort and support during long procedures
- 16" round fully padded
- Height adjustment of 24³/₈" to 29¹/₂"

Part No. P-6000-PR and P-6001

●● **P-526-PR** Procedure Rest

- Rotates a full 360 degrees
- Upholstered for comfort
- Special density foam provides comfort and support during long procedures
- 14¹/₂" round fully padded seat
- Height adjustment of 21¹/₂" to 23³/₄"

Part No. P-526-PR and P-526-GS

upholstery chart

Classic

Durable, vinyl based fabrics, Pedigo Classic upholstery is latex-free and California TB-117 approved.

Indicates: Pedigo Classic upholstery and unit testing:

- California TB-117



Grey



Steel



Beige



Burgundy



Fairway



Lake Blue



Black

PreFixx®



✓ LATEX-FREE

Royal

Environment friendly, Pedigo Royal upholstery is latex-free, PVC-free, California TB-117 approved.

Indicates: Pedigo Royal upholstery and unit testing:

- California TB-117
- California TB-117 and TB-133 approved



Glacier



River Rock



Cattail



Basalt



Orchard Plum



Columbia Blue



Raven Black



✓ LATEX-FREE

✓ PVC-FREE

Above color samples are representations of upholstery materials. Actual colors may vary slightly. Material samples available upon request.

Technical Bulletins The State of California developed a number of testing standards known as Technical Bulletins for the purpose of evaluating the flammability of furniture.

- **CAL TB-117** Flammability test for the filling or padding material of furniture. Tests the flame retardance of resilient filling materials used in upholstered furniture - including the fabric.



- **CAL TB-133** A full-scale fire test of the entire unit including the frame, foam and upholstery.



- **American National Standard for Office Furnishings**

This standard is intended to provide manufacturers, specifiers, and users with a common basis for evaluating the safety, durability, and structural adequacy of general-purpose office chairs. For example, load and impact testing.



- **Business & Institutional Furniture Manufacturer's Assoc.**

A not-for-profit organization that advocates, informs and develops standards for the North American office and institutional furniture industry.

PreFixx®

Care Instructions

PreFixx® is engineered so that upholstery can be cleaned again and again without showing signs of wear. With easy cleanability, and proven stain and abrasion resistance, PreFixx protective finish can reduce maintenance costs and frequent re-upholstery.

Performance: Offers state-of-the-art resistance against staining, burnishing, abrasion, scuffing and blocking.

Durability: Creates a barrier that resists stains from penetrating to the surface of the vinyl for proven, long-lasting protection. With laboratory-tested stain resistance and improved wear properties, upholstery treated with PreFixx protective finish can retain a "like-new" appearance longer.

Easy Maintenance: Enables most common stains like dirt and smudges to wipe off easily. Many difficult stains like ballpoint ink also can be cleaned with active solvents, such as nail polish remover, without damaging the PreFixx protective finish (when recommended cleaning instructions are followed).



shown with optional
bassinet and pad

P-1110-B-SS
bassinet stand with drawer

new!
**co·re
caster™**

bassinet

P-1110-B-SS features

- Side mounted drawer measures:
16½"W x 21¼"L x 3⅛"H
- Design allows close approach from both sides
- Basket can be raised at either end
- 3" double ball bearing swivel casters

frame size

18¼"W x 31"L x 37¾"H
(Height with bassinet basket: 41"H)



shown with optional
bassinet and pad

P-1110-SS
bassinet stand

features

- Design allows close approach from both sides
- Basket can be raised at either end
- 3" double ball bearing swivel casters

frame size

- 18¼"W x 31"L x 37¾"H
- Height with bassinet basket: 41"H



shown with optional
bassinet and pad

P-1110-A-SS
bassinet stand with drawer

features

- End mounted drawer measures:
16½"W x 13¼"L x 7⅜"H
- Design allows close approach from both sides
- Basket can be raised at either end
- 3" double ball bearing swivel casters

frame size

- 18¼"W x 31"L x 37¾"H
- Height with bassinet basket: 41"H



shown with optional bassinet and pad

P-1115-A-SS

bassinet cabinet

features

- Bassinet carriage slides back to allow working area
- Friction lock secures the bassinet in both open and closed positions
- Removable internal shelf, positioned in middle left compartment
- 4" double ball bearing swivel casters

dimensions

- 19³/₄"W x 30⁷/₈"L x 37¹/₄"H
- Height with bassinet 44¹/₈"

cabinet dimensions

- 17"W x 29¹/₂"L x 24⁷/₈"H

drawer frame with removable pan

- 11¹/₄"W x 16¹/₂"L x 4"H



shown with optional bassinet and pad

P-1115-SS

bassinet cabinet

features

- Bassinet carriage slides back to allow working area
- Friction lock secures the bassinet in both open and closed positions
- Removable internal shelf, positioned in middle left compartment
- 4" double ball bearing swivel casters

dimensions

- 19³/₄"W x 30⁷/₈"L x 37¹/₄"H
- Height with bassinet 44¹/₈"

cabinet dimensions

- 17"W x 29¹/₂"L x 24⁷/₈"H

drawer frame with removable pan

- 11¹/₄"W x 16¹/₂"L x 4"H



ST-1833-SS

pediatric scale table

features

- Designed for use with common electronic scales
- Oversize 4" casters for easy movement
- One brake caster for stability

dimensions

- 33"W x 18"D x 35¹/₂"H

OPTIONS



Part No. 53
Bassinet Basket

basket measures

16"W x 30¹/₄"L x 9⁵/₈"H



Part No. 54
Bassinet Pad - Grey

pad measures

12¹/₂"W x 26¹/₂"L x 1" Thick



Wall cabinet P-8535 with sloped top

wall cabinets

features

- Stainless steel cabinetry to maximize storage and space utilization
- Double panel doors with FDA approved polyethylene foam for glass shock resistance
- $\frac{3}{16}$ " tempered glass doors with stainless steel lockable paddle latch
- Radius glass panels for ease of cleaning
- Adjustable stainless steel door hinges
- Stainless steel shelves adjustable in $\frac{1}{2}$ " increments

options

- Keyed door latch
- Stainless steel pegboard
- Additional shelves
- Solid doors

wall cabinets with glass doors

Part No.	Dimensions	Shelves	Doors	Top
P-8510	25 $\frac{3}{4}$ "W x 13"D x 30"H	2	1	Flat
P-8515	25 $\frac{3}{4}$ "W x 13"D x 39"H	2	1	Sloped
P-8530	47"W x 13"D x 30"H	2	2	Flat
P-8535	47"W x 13"D x 39"H	2	2	Sloped
P-8610	25 $\frac{3}{4}$ "W x 13"D x 36"H	2	1	Flat
P-8615	25 $\frac{3}{4}$ "W x 13"D x 45"H	2	1	Sloped
P-8630	47"W x 13"D x 36"H	2	2	Flat
P-8635	47"W x 13"D x 45"H	2	2	Sloped
P-8710	25 $\frac{3}{4}$ "W x 13"D x 48"H	3	1	Flat
P-8715	25 $\frac{3}{4}$ "W x 13"D x 57"H	3	1	Sloped
P-8730	47"W x 13"D x 48"H	3	2	Flat
P-8735	47"W x 13"D x 57"H	3	2	Sloped

wall cabinets with solid doors

Part No.	Dimensions	Shelves	Doors	Top
P-8511	25 $\frac{3}{4}$ "W x 13"D x 30"H	2	1	Flat
P-8516	25 $\frac{3}{4}$ "W x 13"D x 39"H	2	1	Sloped
P-8531	47"W x 13"D x 30"H	2	2	Flat
P-8536	47"W x 13"D x 39"H	2	2	Sloped
P-8611	25 $\frac{3}{4}$ "W x 13"D x 36"H	2	1	Flat
P-8616	25 $\frac{3}{4}$ "W x 13"D x 45"H	2	1	Sloped
P-8631	47"W x 13"D x 36"H	2	2	Flat
P-8636	47"W x 13"D x 45"H	2	2	Sloped
P-8711	25 $\frac{3}{4}$ "W x 13"D x 48"H	3	1	Flat
P-8716	25 $\frac{3}{4}$ "W x 13"D x 57"H	3	1	Sloped
P-8731	47"W x 13"D x 48"H	2	2	Flat
P-8736	47"W x 13"D x 57"H	2	2	Sloped



P-8230 Free-standing cabinet



Built-in cabinets with trim bezel



Sloped top with caster base

operating room cabinets

features

- Stainless steel cabinetry to maximize storage and space utilization
- Available as free-standing, built-in, or caster base models
- Adaptable to custom installations
- Radius glass panels for ease of cleaning
- Adjustable stainless steel door hinges
- Keyed door latch
- Adjustable nylon floor glides for leveling
- $\frac{3}{16}$ " tempered glass doors with stainless steel lockable paddle latch
- Double panel doors with FDA approved polyethylene foam for glass shock resistance
- Stainless steel shelves adjustable in $\frac{1}{2}$ " increments

options

- Stainless steel
- Built-in designs
- Trim bezel for built-in applications
- Caster base with locking casters (Cabinet model height will vary - consult drawing)
- Solid doors
- Additional shelves

operating room cabinet

dimensions

Part No.	Dimensions	Shelves	Doors	Top
P-8010	25 ³ / ₄ "W x 18"D x 60"H	3	Single	Flat
P-8015	25 ³ / ₄ "W x 18"D x 72"H	3	Single	Sloped
P-8020	25 ³ / ₄ "W x 24"D x 60"H	3	Single	Flat
P-8025	25 ³ / ₄ "W x 24"D x 75 ⁵ / ₈ "H	3	Single	Sloped
P-8030	47"W x 18"D x 60"H	3	Double	Flat
P-8035	47"W x 18"D x 72"H	3	Double	Sloped
P-8040	47"W x 24"D x 60"H	3	Double	Flat
P-8045	47"W x 24"D x 75 ⁵ / ₈ "H	3	Double	Sloped
P-8070	35 ³ / ₈ "W x 18"D x 60"H	3	Double	Flat
P-8075	35 ³ / ₈ "W x 18"D x 72"H	3	Double	Sloped
P-8080	35 ³ / ₈ "W x 24"D x 60"H	3	Double	Flat
P-8085	35 ³ / ₈ "W x 24"D x 75 ⁵ / ₈ "H	3	Double	Sloped
P-8110	25 ³ / ₄ "W x 18"D x 72"H	4	Single	Flat
P-8115	25 ³ / ₄ "W x 18"D x 84"H	4	Single	Sloped
P-8120	25 ³ / ₄ "W x 24"D x 72"H	4	Single	Flat
P-8125	25 ³ / ₄ "W x 24"D x 87 ⁵ / ₈ "H	4	Single	Sloped
P-8130	47"W x 18"D x 72"H	4	Double	Flat
P-8135	47"W x 18"D x 84"H	4	Double	Sloped
P-8140	47"W x 24"D x 72"H	4	Double	Flat
P-8145	47"W x 24"D x 87 ⁵ / ₈ "H	4	Double	Sloped
P-8170	35 ³ / ₈ "W x 18"D x 72"H	4	Double	Flat
P-8175	35 ³ / ₈ "W x 18"D x 84"H	4	Double	Sloped
P-8180	35 ³ / ₈ "W x 24"D x 72"H	4	Double	Flat
P-8185	35 ³ / ₈ "W x 24"D x 87 ⁵ / ₈ "H	4	Double	Sloped
P-8210	25 ³ / ₄ "W x 18"D x 84"H	5	Single	Flat
P-8215	25 ³ / ₄ "W x 18"D x 96"H	5	Single	Sloped
P-8220	25 ³ / ₄ "W x 24"D x 84"H	5	Single	Flat
P-8225	25 ³ / ₄ "W x 24"D x 99 ⁵ / ₈ "H	5	Single	Sloped
P-8230	47"W x 18"D x 84"H	5	Double	Flat
P-8235	47"W x 18"D x 96"H	5	Double	Sloped
P-8240	47"W x 24"D x 84"H	5	Double	Flat
P-8245	47"W x 24"D x 99 ⁵ / ₈ "H	5	Double	Sloped
P-8270	35 ³ / ₈ "W x 18"D x 84"H	5	Double	Flat
P-8275	35 ³ / ₈ "W x 18"D x 96"H	5	Double	Sloped
P-8280	35 ³ / ₈ "W x 24"D x 84"H	5	Double	Flat
P-8285	35 ³ / ₈ "W x 24"D x 99 ⁵ / ₈ "H	5	Double	Sloped



Easily add additional storage space with Pedigo wall shelves.

wall shelves

features

- Stainless steel construction
- Pre-drilled for convenient wall mounting
- Shelves are available in a variety of sizes



P-624-SS
6"D x 24"W



P-630-SS
6"D x 30"W



P-636-SS
6"D x 36"W



P-824-SS
8"D x 24"W



P-830-SS
8"D x 30"W



P-836-SS
8"D x 36"W



P-7202

Cardiac & Anesthesia Cabinet

Overall Size

28½"W x 19¼"D x 37¾"H

Top Drawers

21¼"W x 16"D x 3"H

Bottom Cabinet

22½"W x 16¾"D x 16"H



shown with optional cart accessories

P-7202-C

Same as P-7202 w/ complete accessory package

optional accessories for P-7202

- O₂ holder (holds 2 E-size tanks)
- 15' electrical outlet cord
- I.V. rod
- Push handle
- Cabinet locking rod

anesthesia & treatment cabinets

P-7202 features

- Designed for cardiac and other emergency uses or as a large anesthesia cabinet
- Provides space for instruments, vials, and other necessary equipment
- 4" double ball bearing swivel casters



new!
co-re
caster™

P-1100-SS

Anesthesia Table with Drawer

Overall Size

21½"W x 15"D x 34½"H

Trays

12⅝" W x 19⅞"L x ⅝"H

Drawer

15¼" W x 12" D x 3"H

features

- Ideal cart for storage of various instruments and supplies
- Two removable stainless steel trays
- Towel bar and two mask hooks
- 3" double ball bearing, corrosion-resistant **co-re casters™**



P-5090

Small Treatment Cabinet

Overall Size

20½"W x 17¼"D x 35¾"H

Drawer

13¼"W x 12"D x 3"H

Bottom Cabinet

14½"W x 14¾"D x 23¾"H

features

- Solid stainless steel retaining rail
- Internal shelf for optimal storage
- Optional locking rod
- 2" double ball bearing swivel casters



new!
co-re
caster™

P-1105-SS

Anesthesia Cabinet with Drawers

Overall Size

19"W x 16¾"D x 33¼"H

Trays

12⅝" W x 19⅞"L x ⅝"H

Upper 3 Drawers

13¼"W x 12"D x 3"H

Bottom Drawer

13¼"W x 12"D x 7¼"H

features

- Provides extra storage space
- Full extending drawer hangers
- 3" double ball bearing, corrosion-resistant **co-re casters™**



P-5091

Large Treatment Cabinet

Overall Size

28½"W x 19¼"D x 35¾"H

Top Drawers

21¼"W x 16"D x 3"H

Bottom Drawer

21¼"W x 16"D x 5⅜"H

Bottom Cabinet

22½"W x 16¾"D x 18"H

features

- Solid stainless steel retaining rail
- Internal shelf for optimal storage
- Optional locking rod
- 2" double ball bearing swivel casters



stretcher series
P-172
 basic transport stretcher

The P-172 Series general transport stretcher provides an economical patient transport solution. This non-hydraulic stretcher series features a 1³/₈" heavy-gauge O.D. tubular frame, continuous rubber bumper, long-life, double ball bearing, 8" swivel casters for quiet movement, and convenient hand holds on each corner.

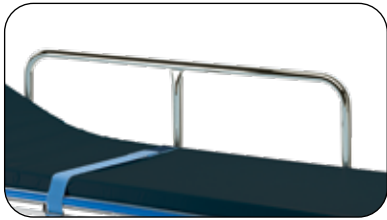

RAIL SYSTEM

Easy to wipe clean and disinfect side rails.

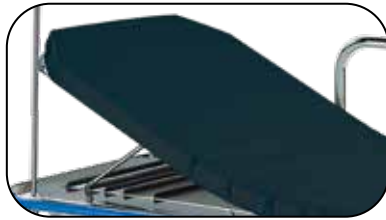

FOWLER HEAD REST

Fowler provides additional assistance for the safe and easy raising and lowering of the patient.

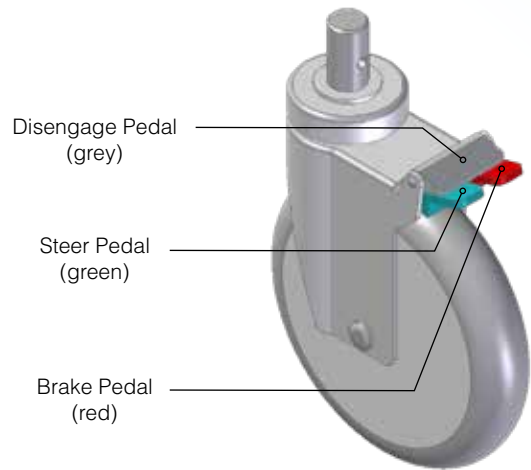

CASTERS

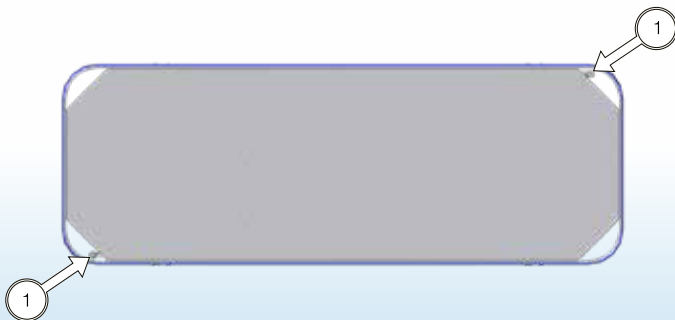

I.V. Poles Socket Locations

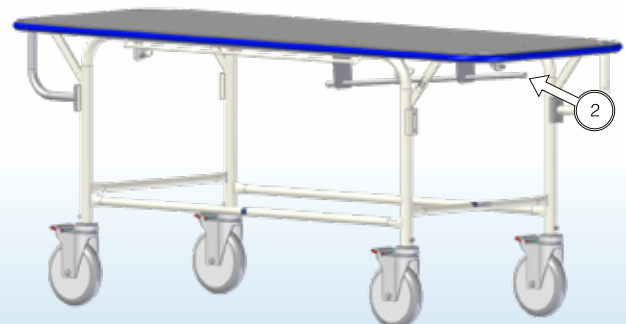

I.V. Pole Storage Tube Location

STANDARD FEATURES

- 350 lbs. weight capacity
- Designed as a cost efficient transport stretcher
- Four Brake & Steer Casters
- Heavy-gauge, 1³/₈" O.D. tubular frame
- Fixed litter top height
- Full perimeter bumper
- Convenient hand holds on each corner
- Long-life polyurethane, double ball bearing, 8" swivel casters for quiet movement
- Latex-free



SPECIFICATIONS

Model Number	P-172
Weight Capacity	350 lbs. (159 kg)
Overall Length	78" (198 cm)
Overall Width	28" (71 cm)
Fixed Height	33 ¹ / ₄ " (85 cm)
Optional Litter Positioning	
Fowler Backrest	3°, 12°, 26°, 38°, 44°
Patient Surface	77" x 26" (196 x 66 cm)
Optional Side Rails	12" x 43" (30 x 109 cm)
Casters	8" (20 cm)
Warranty	1 year parts and labor

P-172 CONFIGURATIONS

	Swivel Caster	Brake & Steer Caster	P-170-1 Shelf	P-170-2 Rails	P-170-3 Fowler	P-170-4 IV Pole	P-170-5 Strap	P-170-6 Bumpers	P-170-8 Mattress	P-170-9 O ₂ Tank Holder
P-172		4								
P-172-C		4	•	•	•	•	•		•	•

OPTIONS

Accessory

Storage Shelf:

Shelf P-170-1

Side Rail:

Stainless Steel..... P-170-2

Fowler:

Stainless Steel..... P-170-3

Accessory

IV Pole:

Fixed Height P-170-4

Restraint Strap:

Velcro..... P-170-5

Rolling Bumpers:

7¹/₂" round rubber..... P-170-6

Accessory

Mattress:

Pad (2¹/₂" thick black) . P-170-8

O₂ Holder:

E Size Tank Holder P-170-9

(requires storage shelf P-170-1)



MATTRESS PAD

Soft-vinyl 2¹/₂" thick black mattress pad measures 26"W x 77"L.



O₂ HOLDER

Bracket for E-size oxygen tank. Requires lower shelf.

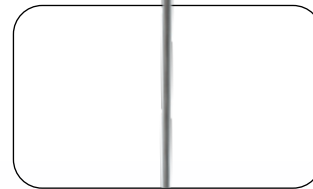

IV POLE

Two hook pole includes holder and storage tube.



FOWLER HEAD REST

Stainless steel construction with an adjustable range from 0° - 45°.



LOWER SHELF

Stainless steel storage shelf.



RESTRAINT STRAP

Blue Velcro restraint strap.



CASTERS

8" double ball bearing casters.

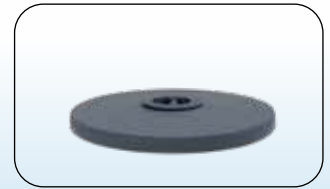

BUMPERS

7¹/₂" rolling rubber bumpers



catalog 2026

